

Service Handbook
HP 9000 Series 700 Model 743

[Go to the Table of Contents](#)



HP Part No. A2636-90604
Edition E1097

© Hewlett-Packard Co. 1997

Printing History

First Printing: October 1997

UNIX is a registered trademark in the United States and other countries, licensed exclusively through X/Open Company Limited.

NOTICE

The information contained in this document is subject to change without notice.

HEWLETT-PACKARD MAKES NO WARRANTY OF ANY KIND WITH REGARD TO THIS MATERIAL INCLUDING BUT NOT LIMITED TO THE IMPLIED WARRANTIES OF MERCHANTABILITY AND FITNESS FOR A PARTICULAR PURPOSE. Hewlett-Packard shall not be liable for errors contained herein or for incidental or consequential damages in connection with the furnishing, performance or use of this material.

Hewlett-Packard assumes no responsibility for the use or reliability of its software on equipment that is not furnished by Hewlett-Packard.

This document contains proprietary information that is protected by copyright. All rights reserved. No part of this document may be photocopied, reproduced or translated to another language without the prior written consent of Hewlett-Packard Company.

RESTRICTED RIGHTS LEGEND. Use, duplication, or disclosure by government is subject to restrictions as set forth in subdivision (c) (1) (ii) of the Rights in Technical Data and Computer Software Clause at DFARS 252.227.7013. Hewlett-Packard Co., 3000 Hanover St., Palo Alto, CA 94304.

10 9 8 7 6 5 4 3 2 1

Safety and Regulatory Statements

Safety

For safety information see the owner's guide that came with the system in which you are installing your Model 743 board computer.

Regulatory Statements

Emissions Regulations

Federal Communications Commission (FCC) This equipment has been tested and found to comply with the limits for a Class A digital device, pursuant to part 15 of the FCC Rules and interference causing regulations of Industry Canada. These limits are designed to provide reasonable protection against harmful interference in a non-residential installation. This equipment generates, uses, and can radiate radio frequency energy and, if not installed and used in accordance with the instructions, may cause harmful interference to radio communications. However, there is no guarantee that interference will not occur in a particular installation. If this equipment does cause harmful interference to radio or television reception (determined by turning the equipment off and on), you can correct the interference by one or more of the following measures:

- Reorient or relocate the receiving antenna.
- Increase the separation between the equipment and the receiver.
- Connect the equipment to an outlet on a circuit different from that to which the receiver is connected.

Hewlett-Packard's system certification tests were conducted with HP-supported peripheral devices and HP shielded cables, such as those you receive with your computer. Changes or modifications not expressly approved by Hewlett-Packard could void the user's authority to operate the equipment.

Safety and Regulatory Statements

Australia EMC Standards

This equipment has applied for and received approval to display the Australian C-Tick mark according to the standards of AS/NZS 2064.1/2:1992 and AS/NZS 3548:1995.

VCCI Class A ITE

この装置は、情報処理装置等電波障害自主規制協議会（VCCI）の基準に基づくクラスA 情報技術装置です。この装置を家庭環境で使用すると電波妨害を引き起こすことがあります。この場合には使用者が適切な対策を講ずるよう要求されることがあります。

Electrostatic Discharge (ESD) Precautions

Electrostatic charges can damage the integrated circuits on printed circuit boards. To prevent such damage from occurring, observe the following precautions during board unpacking, installation, and configuration:

- Stand on a static-free mat.
- Wear a static strap to ensure that any accumulated electrostatic charge is discharged from your body to ground.
- Connect all equipment together, including the static-free mat, static strap, routing nodes, and peripheral units.
- Keep uninstalled printed circuit boards in their protective antistatic bags.
- Handle printed circuit boards by their edges, once you have removed them from their protective antistatic bags.

Electrostatic Discharge (ESD) Precautions

Contents

Preface

Safety and Regulatory Statements iii

Safety iii

Regulatory Statements iii

Emissions Regulations iii

Australia EMC Standards iv

VCCI Class A ITE iv

Electrostatic Discharge (ESD) Precautions v

1

Product Information

Product Description 1-2

Technical Information 1-6

Electrical 1-6

Regulatory Compliances 1-7

Environmental Requirements 1-7

Hardware Support 1-9

Field Repair Philosophy 1-9

Additional Technical Information 1-9

Schematics 1-9

Supported Products 1-10

Accessory Cards 1-11

Typical External Devices 1-12

Cables 1-12

Contents

Keyboard and Mouse 1-13

Repair Services 1-14

2 Functional Description

Overview 2-2

System Board 2-2

CPU Circuit 2-4

Boot ROM Circuit 2-4

System Failure LED 2-5

Power LED 2-5

Graphics Circuit 2-6

Keyboard 2-7

Memory Controller Circuit 2-7

Memory Map 2-8

I/O Controller ASIC 2-10

Built-in Interfaces 2-11

Audio 2-11

HP Parallel 2-13

RS-232 Ports 2-14

AUI LAN 2-16

SCSI 2-17

PS/2 Ports 1 and 0 2-19

VME Controller ASIC 2-20

Graphics Accessory Cards 2-23

RAM Cards 2-24

Interval Timers 2-26

Contents

Watchdog Timer 2-26

Power Distribution 2-27

3 Configuration

Introduction 3-2

Boot Console Handler 3-3

 Overview of the Boot Console Handler 3-3

Using the Boot Console Handler 3-4

Boot From a Device Menu 3-7

Path Configuration Menu 3-9

 Primary or Alternate Path Menus 3-10

 Console Path Menu 3-10

 Keyboard Path Menu 3-11

Mode Configuration Menu 3-12

 Setting Values in the Mode Configuration Menu 3-13

 Mode Configuration Menu Selections 3-14

 Boot Search Control 3-14

 Console Search Control 3-15

 Keyboard Search Control 3-15

 Test Configuration 3-15

 Control Flags 3-16

Interactive Testing 3-18

 Interactive Testing Limitations 3-19

Contents

- Accessing Firmware Information 3-21
- Hardware Information 3-23
- ASIC Hardware Component Information 3-25
 - Graphics Information 3-26
- System Configuration Menu 3-27
- Graphics Configuration 3-29
 - Graphics Information in Menus 3-29

4 Troubleshooting

- Introduction to Troubleshooting 4-2
 - Diagnostic Overview 4-2
 - ISL Environment 4-3
- Boot ROM Selftests 4-4
 - Hardware Initialization Support 4-5
 - Go/No-Go Selftest Support 4-5
 - Failure Indications 4-5
 - Early Selftest 4-6
 - Read/Write Memory Test 4-6
 - Read-Only Memory Test 4-6
 - Late Selftest 4-6
 - Extended Selftest 4-6
- Firmware Selftest Failures 4-8
 - Interpreting the Front Panel LEDs 4-8

Contents

Boot Options 4-10

Interactive Testing Menu 4-13

Running ODE-Based Diagnostics 4-14

Determining the Faulty RAM Card 4-15

Running System Verification Tests 4-16

Dealing with HPMC (Uncorrectable Error) 4-18

 HPMC Caused by a Data Cache Parity Error 4-22

 HPMC Caused by a Multi-Bit Memory Parity Error 4-23

 Interpreting the Table 4-23

 Determining the Faulty Memory Card 4-24

Chassis Test Codes 4-25

 Introduction 4-25

 Interpreting Chassis Codes 4-25

 Chassis Code Terms 4-26

5

Field Replaceable Units

Introduction 5-2

 New Parts 5-2

 Exchange Parts 5-2

 Local Office Information 5-3

Replaceable Parts 5-4

Tools Required and Preliminary Procedures 5-7

 Tools Required for Assembly/Disassembly 5-7

Contents

Preliminary Procedures 5-7

Safety Precautions 5-8

Removing and Replacing the 743 Board Computer 5-9

 Preliminary Requirements 5-9

 Removal 5-9

 Replacement 5-10

Replacing a 743 System Board 5-11

 Preliminary Requirements 5-11

Removing and Replacing RAM Cards 5-13

 Preliminary Requirements 5-13

 Spacer/Standoffs 5-13

 Removal 5-14

 Replacement 5-14

Removing and Replacing GSC Cards 5-15

 Preliminary Requirements 5-15

 Removal 5-15

 Replacement 5-16

Removing and Replacing the GSC Adapter 5-17

 Preliminary Requirements 5-17

 Removal and Replacement 5-17

Removing and Replacing the PMC Adapters 5-19

 Preliminary Requirements 5-19

 Removal and Replacement 5-19

Removing and Replacing an
HCRX Graphics Board 5-26

 Preliminary Requirements 5-26

Contents

Removal 5-26

Replacement 5-27

Removing and Replacing the Front Panel Extension 5-28

Preliminary Requirements 5-28

Removal and Replacement 5-28

Removing and Replacing the Front Panel 5-30

Preliminary Requirements 5-30

Removal and Replacement 5-30

Socketed ICs 5-31

Preliminary Requirements 5-31

Removing and Replacing Socketed ICs 5-31

Removing and Replacing the
Real-Time Clock Battery 5-33

Preliminary Requirements 5-33

Replacement 5-33

Removing and Replacing the PCMCIA Adapter 5-34

Removal 5-34

Replacement 5-34

6 Reference Documentation

Introduction 6-2

Contents

Figures

Model 743 VMEbus Board Computer Temperatures	1-8
Model 743 VMEbus Board Computer Top and Front View	2-3
Video Connector	2-6
Audio Connector	2-12
HP Parallel Connector	2-13
RS-232 Serial Connector	2-15
AUI LAN Connector	2-16
SCSI Connector	2-17
PS/2 Connector	2-19
Power Distribution Diagram	2-28
Model 743 LED Location	4-8
Model 743 Board Computer Exploded View	5-4
Captive Screws: Single and Dual Slot 743	5-9
Retaining Screws and Standoffs	5-14
GSC Fasteners	5-16
Extension Adapter Fasteners	5-18
Removing the Labels and Springs	5-20
Removing the Sleeves	5-21
Removing the PMC Expansion Adapter	5-22
Removing a PMC card from the Expansion Adapter	5-23
Removing the PMC Bridge Adapter	5-24
Removing a PMC card from the Bridge Adapter	5-25
HCRX Board Fasteners	5-27
Front Panel Extension Fasteners	5-28
Port Jack Screws	5-30
Removable ICs	5-32

Contents

Tables

Model 743 Power Requirements 1-6
Regulations 1-7
Environmental Requirements 1-7
LED Indicators 2-5
Video Connector Pins and Signals 2-6
Main Memory map 2-8
I/O Controller ASIC Memory Map 2-10
Audio Interface Specifications 2-12
Audio Connector Pinouts 2-12
HP Parallel Interface Specifications 2-13
HP Parallel Connector Pinouts 2-14
RS-232-C Specifications 2-14
RS-232-C Connector Pinouts 2-15
AUI LAN Connector Pinouts 2-16
SCSI Interface Specifications 2-17
SCSI Connector Pinouts 2-18
PS/2 Connector Pinouts 2-19
VME P1/J1 Pin Assignments & Signal Mnemonics 2-20
VME P2/J2 Pin Assignments & Signal Mnemonics 2-21
Supported Graphics Configurations 2-23
RAM Failure Chassis Codes vs. RAM Slot 2-24
Real-Time Clock Specifications 2-25
Interval Timer Specifications 2-26
Model 743 Board Computer Power Requirements 2-27
Main Menu Options 3-5
Paths for Booting and Human Interfaces 3-10
Mode Configuration - Control Flags 3-16
Interactive Tests 3-19
Firmware Information ROM Identification 3-22
Graphics Sub-System Combinations 3-29
LED Indicators 4-9
Interactive Tests 4-13
RAM Stack Cards 4-15
PIM Action Table 4-19

Contents

Processor Module Error (Data Cache Parity) 4-22
Multi-Bit Memory Parity Error 4-23
Memory Address Ranges 4-24
Chassis Code Terms 4-26
Chassis Codes 4-27
Replaceable Parts 5-5
Reference Documentation 6-2

Product Information

Product Description

The HP 9000 Model 743 is a high-performance Precision Architecture board computer based on the Hewlett-Packard PA-RISC 7100LC technology. It contains the following key features:

- Model type:
 - Model 743i/64
 - Model 743rt/64
 - Model 743i/100
 - Model 743rt/100
- VME slot configuration
 - Single slot
 - Dual slot (requires PCI Mezzanine Card (PMC) bridge board, General System Connect (GSC) expansion kit or HCRX graphics board)
 - Three slot (requires PMC bridge and expansion boards or GSC expansion kit with ATM card)
- CPU PA-RISC PA7100-LC, processor performance
 - 64 or 100 MHz
 - Cache - 256 KB
- Clocks
 - Battery-backed real-time clock
 - Interval timers (One 32 bit, Two 16 bit)
 - Watchdog timer
- Operating systems
 - HP-UX 9.05 (or later; some options require later releases). The Model 743 typically boots from a hard disk drive. HP-UX may also be installed from an external DDS or CD-ROM drive.

If the Model 743 is a client on a LAN, HP-UX can be booted over the LAN.

HP-RT 2.0 and later.

- User interface

CDE or HP VUE graphical user interface (HP-UX only)

- Compatibility

Source and binary code compatible with Series 700 product family.

- Monitors

Single or multiple display depending on number of installed graphics options (onboard and/or external).

Color monitors:

HP A4490D, 17-inch, resolution 1280 x 1024

HP A4331D, 20-inch, resolution 1280 x 1024

Terminal (text only) connected to RS-232 port.

- Optional Graphics Capability

Graphics chip set providing onboard (including accelerated I/O) graphics.

GSC expansion kit provides two slots for GSC HP A4267A 8-plane graphic cards.

HCRX8 or HCRX24 graphics boards allow the choice of one HP A4267A graphics card in addition to the graphics board itself.

HP-RT supports an expansion kit with an HP A4267A graphics card or an HCRX graphic board when on-board graphics is not used.

NOTE: Either a GSC expansion kit or the HCRX expansion graphics boards extend graphics capability beyond the onboard graphics chip set of a Model 743 board computer. However, the HP-RT operating system supports only one graphics display, and HP-UX 10.x supports up to three graphics displays.

- Main Memory

Single VME slot 743i: 16 to 128 MB RAM

Single VME slot 743rt: 8 to 128 MB RAM

Dual VME slot 743i: 16 to 256 MB RAM

Dual VME slot 743rt: 8 to 256 MB RAM

(Dual slot means an expansion kit or HCRX board must be installed.)

NOTE: A Model 743 configured for more than two RAM cards (one in each RAM stack) requires installation of an expansion kit or an HCRX graphics board and occupies two VME slots.

Up to four RAM cards may be installed - three cards in RAM stack 1, one card in RAM stack 2.

RAM cards may be placed in any order. A higher capacity memory card can be added on top of a lower capacity card or you can reverse the order, with a lower capacity card on top of a higher capacity card.

- Standard Features

Internal SCSI-2 single-ended bus

2 asynchronous RS-232-C ports (requires a conversion cable)

1 HP parallel port (requires a conversion cable)

1 LAN AUI port (requires a conversion cable)

2 mini-DIN PS/2 ports

1 slot for RAM memory (memory cards can be stacked)

CD-quality audio, supported only by HP-UX and requires a conversion cable

PCMCIA adapter, supported only by HP-RT

- Dual Slot Upgrades

PMC bridge board (with two PMC sites, cannot be used w/

HCRX, and supported only on HP-UX)
GSC expansion kit (with two GSC sites)
HCRX8 graphics board (with one additional GSC site)
HCRX24 graphics board (with one additional GSC site)
GSC HP A4267A graphics card
FWD SCSI card

- 3-slot Upgrade

PMC expansion board (with two PMC sites, requires PMC bridge)

ATM Network Card (up to 2, GSC expansion kit required, cannot be used with HCRX graphics)

- Other Supported Configurations

Hewlett Packard supports only products with HP approved parts, accessories, peripherals, operating systems, and application programs.

Technical Information

This section lists technical information for the Model 743. For official specifications, refer to the HP 9000 Series 700i/rt Technical Data Sheet for Models 743i/rt and 748i VMEbus Computer Systems.

Electrical

This section lists the electrical requirements for the Model 743. The following table shows the power requirements for a 743 without on-board graphics.

Table 1-1 **Model 743 Power Requirements**

Assembly	Model 743/64			Model 743/100		
	+5	-12	+12	+5	-12	+12
System board ^a	6.1A	0.1A	0.1A	7.5A	0.1A	0.1A
RAM Cards	0.2A	0	0	0.2A	0	0
On-board graphics	0.6A	0	0	0.75A	0	0
Graphics card, 8-bit	0.6A	0	0	0.75A	0	0

a. No on-board graphics, RAM, or accessory cards.

Regulatory Compliances

The 743i and the 743rt comply with the regulations listed in Table 1-2.

Table 1-2 Regulations

Safety	UL 1950, CSA22.2 950-M, EN60950
Electromagnetic Certification	FCC 47 cfr. part 15 sub part J Class A; VCCI Class A; EN55022/CISPR22 Class A; Australia C-Tick AS/NZS 2064.1/2:1992 and AS/NZS 3548:1995

Environmental Requirements

The following table shows the environmental requirements for the Model 743.

Table 1-3 Environmental Requirements

Temperature	Operating: 0° to 55°C; 10°c/min rate of change maximum Non-operating: -40° to 70°C
Humidity	Operating: 40°C: 95% RH max
Altitude	Operating: 4,600m (15,000 ft) to 40°C Non-operating: 15,300m (50,000 ft) to 70°C
Air flow	150 linear feet per minute, 0° to 35°C 200 linear feet per minute, 35° to 55°C

CAUTION: Integrated circuit case temperatures must not exceed those shown in the following figure.

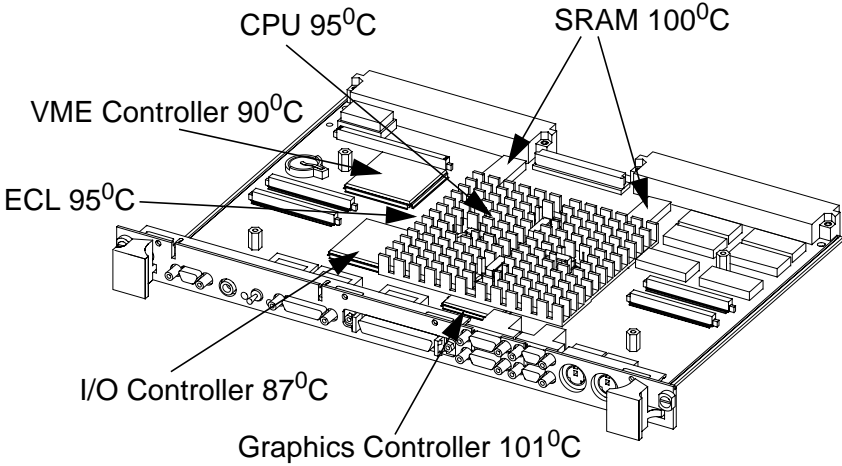

Figure 1-1 Model 743 VMEbus Board Computer Temperatures

NOTE: The Model 743 should only be operated in an environment that is free from conductive pollution, including dry non-conductive pollution which could become conductive due to expected condensation.

Hardware Support

This section provides information on the hardware support for the Model 743.

Field Repair Philosophy

If a problem or failure occurs with the Model 743, the problem is diagnosed to the assembly having the failed part. That assembly is then replaced. In some cases, an assembly may be exchanged for rebuilt assembly. Other assemblies may only available as new. Refer to Chapter 5 for information on replacement parts.

Additional Technical Information

Additional technical information on these products can be found in the HP 9000 Series 700i/rt Model 743i/rt and 748i VMEbus Computer Systems Technical Data Sheet.

Schematics

Hewlett-Packard support is limited to field-replaceable assemblies. Schematics are not available for repair purposes to component level.

Supported Products

Only products with Hewlett-Packard approved parts, accessories, peripherals, operating systems, and application programs are supported by Hewlett-Packard. Any product with other than HP approved hardware or software connected or installed must have the non-HP approved hardware and software removed by the customer before On-Site repair is conducted. The following lists describe the products supported by HP.

Accessory Cards

The Model 743 supports the following accessory cards:

- Memory; one or more of these RAM cards supported on both HP-UX and HP-RT operating systems:
 - HP A4263A 8 Mbyte RAM Card
 - HP A4264A 16 Mbyte RAM Card
 - HP A4265A 32 Mbyte RAM Card
 - HP A4266A 64 Mbyte RAM Card
- HP A4504A PMC Bridge Adapter - provides two sites for third party PMC cards (HP-UX only)
- HP A4509A PMC Expansion Adapter - provides two additional sites for third party PMC cards (requires PMC Bridge Adapter - HP-UX only)
- HP A4262A GSC Expansion Kit
- GSC Mezzanine cards:
 - HP A4267A 8-Plane Color Graphics Card
 - HP A4268A FWD SCSI
 - HP J3420A ATM (supported only by HP-UX)
- PCMCIA (supported only by HP-RT)
 - 10-MB Flash disk card
 - 20-MB Flash disk card
 - 40-MB Flash disk card (HP-RT 3.0 and later - not available from HP)
- Sub-Mezzanine Cards:
 - HCXR8 graphics card
 - HCRX24 graphics card

Typical External Devices

The Model 743 supports the following external devices:

- LAN Transceiver:
 - HP A2670A ThinLAN Ethernet Transceiver
 - HP A2671A EtherTwist Transceiver.
- Speaker; 8 ohm impedance with $\frac{1}{8}$ -inch sub-miniature stereo connector (HP-UX only).

Cables

The Model 743 supports the following cables:

- Conversion cables:
 - HP A4300A HP Parallel; High-Density 25-Pin to Standard 25-Pin F
 - HP A4301A RS-232; High-Density 9-Pin to Standard 9-Pin M
 - HP A4302A Audio; High-Density 9-Pin to Stereo Line-In
 - HP A4303A LAN; High-Density 15-Pin to 15-Pin AUI
 - HP A4304A Video; High-Density 15-Pin to Standard 15-Pin F
 - HP A4305A Video; High-Density 15-Pin to EVC connector
 - HP A4167A Video; Standard 15-Pin M to EVC connector (for use with GSC graphics card and EVC monitor)
- Standard cables:
 - HP K2296 SCSI; High-Density 50-Pin to Standard Bail Lock
 - HP 92284A HP Parallel; 25-Pin M to 25-Pin M
 - HP 24542G RS-232 Terminal Cable; 9-Pin F to 25-Pin M
 - HP 24542H RS-232 Modem Cable; 9-Pin F to 25-Pin F

Keyboard and Mouse

The Model 743 supports the following:

- HP A2840A Keyboard with mini-DIN connector
- HP A2839A Mouse with mini-DIN connector

Repair Services

Hewlett-Packard supports three types of repair services:

- **Return to Hewlett-Packard Repair** - Customers can return the product to their local HP Sales and Service Office. An HP Bench Repair Engineer troubleshoots and repairs the hardware to the assembly level. The repair engineer may replace the defective assembly with a new or rebuilt assembly. The product is then returned to the customer. This service is available through a service contract or a time-and-materials basis.
- **On-Site Repair** - On-Site Repair is performed at the customer's site. This service is available through a service contract or a time-and-materials basis.
- **Customer Repair** - Customers have the option of repairing their own HP products. Contact your nearest Hewlett-Packard Sales and Service Office for information concerning service training, special tools, test equipment, and spare parts.



Functional Description

Overview

This chapter describes the functional features of the Model 743.

System Board

The system board provides the following functionality to the Model 743:

- CPU
- Boot ROMs
- Graphics
- Memory controller
- VME interface
- I/O controller, which controls the following interface circuits:
 - LAN
 - Single-ended SCSI
 - HP Parallel
 - Audio
 - RS-232

Figure 2-1 shows a top and front view of the Model 743 Board Computer.

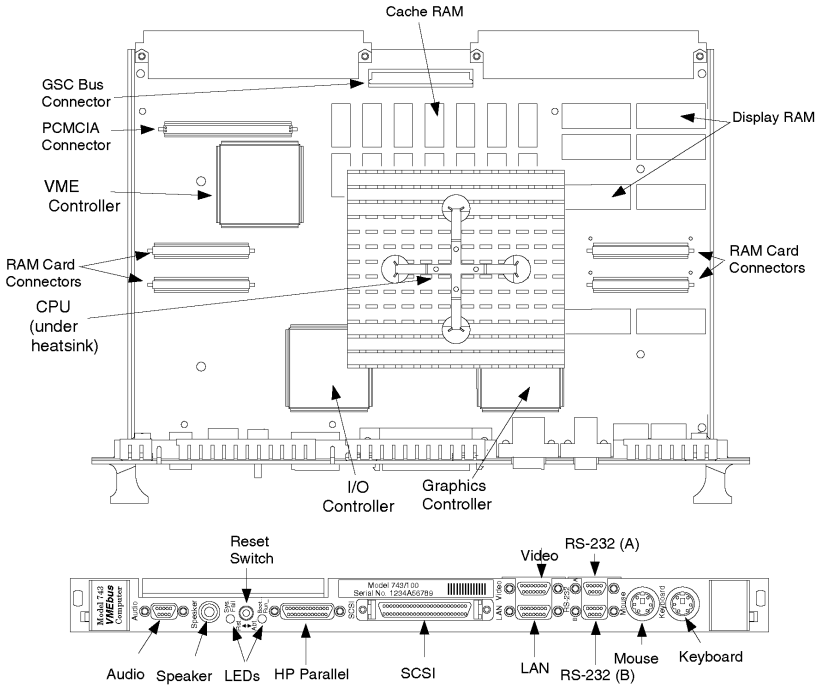

Figure 2-1 Model 743 VMEbus Board Computer Top and Front View

CPU Circuit

The HP PA-RISC 7100 CPU chip is located beneath the heat sink in the center of the board.

Boot ROM Circuit

The Boot ROM circuits:

- Start the CPU functions
- Self-test the board computer's main circuits
- Search for and boot an operating system
- Manage the internal interface configurations

An EEPROM stores information for:

- Internal interface configurations
- LAN ID number

NOTE:

The workstation's LAN ID number's last 6 characters are labeled on the EEPROM. The first group of digits are typically 080009. If the system board or EEPROM is replaced, the system administrator uses the complete LAN ID number to reconfigure the networked system.

Should replacement be necessary for these parts, the customer is responsible for providing replacement custom OEM ROMs.

A Program Timer Module contains the system clock. All timing is based on the system clock. The Boot ROM circuits involve several important boot and configuration functions.

The Model 743 has two LEDs; one red, and one green, that indicate various system functions. Table 2-1 shows the meaning for each LED.

System Failure LED

This red LED turns on momentarily when power-up functions occur. It goes out after the board computer finds the VMEbus services as the operating system boots.

During normal operation, should VMEbus services fail, the system fail LED turns on.

Power LED

A green LED indicates either a failure or functional mode, depending on the on-off rate.

Table 2-1 lists the blinking rates and their meaning.

Table 2-1 LED Indicators

SYSFAIL (Red)	POWER (Green)	Meaning	Possible Solution
Off	Off	No Power	Check for board seating in chassis.
On	2Hz Flash	Normal Power-on/selftest	
On	Off	Memory Failure	Troubleshoot for failed RAM card or problem with the RAM connection.
On	1 Flash/sec.	CPU (board) Failure	Replace the system board.
On	4 Flash/sec.	No console identified	Check the console search path and keyboard connections. If no problem is found, replace the system board.
On	On	OS is booted with VME services failure	Check the Operating System VME services. Check that VME services is configured in the kernel.
Off	On	OS is booted with VME services OK	

Graphics Circuit

System boards with on-board graphics circuit have the display RAM and can be configured for several types of monitors. Graphic monitors connect to the 15-pin video connector. Figure 2-2 shows the video connector, and Table 2-2 shows the video connector pinouts.

Figure 2-2 Video Connector

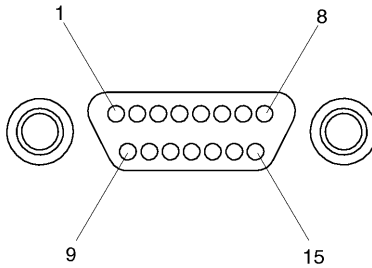

Table 2-2 Video Connector Pins and Signals

Pin Number	Signal	Pin Number	Signal
1	GND	9	GND
2	GND	10	HSYNC
3	RED	11	GND
4	GND	12	GND
5	GREEN	13	NC
6	GND	14	GNC
7	BLUE	15	VSYNC
8	GND		

Keyboard

A keyboard must be connected to either the PS/2 0 or PS/2 1 port if graphics are used as part of the console path. When a graphics device is specified as the console path, the boot ROM first checks for a keyboard using the keyboard search list. If the system does not find a keyboard as part of the console path, graphics will not be enabled.

Memory Controller Circuit

Memory is managed by the CPU's memory controller circuit. You can install up to 256 Mbytes of RAM. An Error Checking and Correcting (ECC) function checks memory word read/write operations and detects both single-bit and double-bit errors. If the ECC detects a single-bit error, it will be corrected. Double-bit errors are detected but not corrected. Triple and quadruple bit errors are grouped in nybbles, using a 64-bit memory bus.

The Model 743 uses two RAM card locations. RAM stacks are labeled on the system board as:

- RAM stack 1, located behind the PS/2 (mouse and keyboard) connectors, supports up to three RAM cards. The physical RAM slot positions are:
 - Bottom RAM card, slot 0
 - Middle RAM card, slot 1
 - Top RAM card, slot 2
- RAM stack 2, located behind the audio connectors supports only one RAM card and is in physical RAM slot 4.

Memory Map

Table 2-3 shows the Main Memory Map for the Model 743.

Table 2-3 Main Memory map

Low Address	High Address	Size	Chip	Description
F000 0000	F01F FFFF	2M	I/O ASIC	I/O ASIC #1 space
F020 0000	F020 7FFF	32K	EISA ASIC	EISA, ASIC non-EISA registers (HPIB, HIL, RS-232)
F020 8000	F027 FFFF	480K	VME ASIC	Future Use
F028 0000	F029 FFFF	128K	VME ASIC	PCMCIA
F02A 0000	F02F FFFF	384K		Future Use
F030 0000	F031 FFFF	128K	VME ASIC	VME ASIC #2 space, VME registers
F032 0000	F03F FFFF	896K		Future Use
F040 0000	F07F FFFF	4M	VME	VME I/O space
F080 0000	F3FF FFFF	56M	VME/PCI	VME/PCI I/O space
F400 0000	F5FF FFFF	32M	Graphics ASIC	Graphics Slot 2
F600 0000	F7FF FFFF	32M	Graphics ASIC	Graphics Slot 3
F800 0000	F9FF FFFF	32M	Graphics ASIC	Graphics Slot 1
FA00 0000	FBFF FFFF	32M	Graphics ASIC	Graphics Slot 4
FC00 0000	FFBF FFFF	60M	EISA ASIC	EISA
FF80 0000	FF90 FFFF	1M	I/O ASIC	I/O ASIC #3 space
FFC0 0000	FFC1 FFFF	128K	VME ASIC	VME ASIC #1, VME registers
FFC0 0000	FFD0 FFFF	1M	I/O ASIC	I/O ASIC #4 space

Table 2-3 Main Memory map

Low Address	High Address	Size	Chip	Description
FFC2 0000	FFDF FFFF	2M		Unused
FFE0 0000	FFE0 7FFF	32K	EISA ASIC	EISA ASIC; GSC+ mode
FFE0 8000	FFF7 FFFF	1504K		Unused
FFF8 0000	FFF8 3FFF	16K	GSC	I/O Flex Module 0
FFF8 4000	FFF8 7FFF	16K	PCI	PCI ASIC #1 registers
FFF8 8000	FFF8 BFFF	16K	GSC	I/O Flex Module 2
FFF8 C000	FFF8 FFFF	16K	PMC	PCI ASIC #2 registers
FFF9 0000	FFFB AFFF	172K	Reserved	
FFFB B000	FFFB BFFF	4K	Reserved	HPMC test
FFFB C000	FFFB DFFF	8K	Reserved	CPU use
FFFB E000	FFFB EFFF	4K	CPU	CPU registers
FFFB F000	FFFB FFFF	4K	CPU	Memory controller
FFFC 0000	FFFF FFFF		CPU	Local/Global Broadcast Processor Space

I/O Controller ASIC

The Model 743 uses an I/O Controller ASIC to control the input and output of the following:

- Audio
- Speaker
- HP Parallel
- RS-232 Port A
- AUI LAN
- SCSI
- PS/2 Ports 1 and 0

The following table lists the I/O controller memory map.

Table 2-4 I/O Controller ASIC Memory Map

Low Address	High Address	Size	Description
F000 0000	F007 FFFF	512K	Main BootROM space
F008 0000	F00B DFFF	248K	OEM/Secondary ROM space
F00B E000	F00B FFFF	8K	X25
F00C 0000	F00F FFFF	256K	EEPROM space
F010 0000	F010 0FFF	4K	Interrupt Registers
F010 1000	F010 1FFF	4K	Parallel port DMA Registers
F010 2000	F010 2FFF	4K	Parallel Interface Registers
F010 3000	F010 3FFF	4K	Parallel Port DMA Reset
F010 4000	F010 4FFF	4K	Audio
F010 5000	F010 5FFF	4K	RS-232
F010 6000	F010 6FFF	4K	SCSI
F010 7000	F010 7FFF	4K	LAN
F010 8000	F010 8FFF	4K	PS2
F010 9000	F010 9FFF	4K	Real Time Clock
F010 A000	F010 AFFF	4K	Reserved
F010 B000	F010 BFFF	4K	Clock Configuration Registers
F010 C000	F010 CFFF	4K	I/O ASIC Registers
F010 D000	F010 FFFF	12K	Reserved

Built-in Interfaces

The system board's built-in interfaces have ports on the front panel. Many of the ports are micro-miniature connectors, requiring special conversion cables to interface with a device's standard connector.

The following sections provide more information on the function of each interface.

Audio

Model 743 board computers provide compact disc-quality audio input and output in stereo with a 16-bit coder-decoder (CODEC) over a frequency range of 25-20,000 Hz. Output is provided by a small internal speaker and a stereo headphone mini-plug (8 Ohms impedance). Input is provided by a stereo line-in and mono microphone mini-plugs.

A Digital Signal Processor (DSP) based option card is provided to enhance the audio subsystem by providing phone and modem functions. Other special DSP applications can also be down-loaded to this card.

The CODEC combines CD quality stereo A/D converters for microphone and line input levels. D/A converters for driving headset and line outputs are used. The input sampling rate and format are programmable, as are the input gain control (used for software control of recording levels) and output attenuation.

A 1/8-inch. mini-jack is used for the speaker out connection. The other audio signals are on a 9 pin micro D-sub connector. The output is capable of driving 8 Ohms; it can also be used for higher impedance devices with little or no additional distortion. A line level input can be driven by the headset output.

For information on programming for audio, refer to *Using the Audio Developer's Kit* (B2355-90069) and the man page *audio*.

Table 2-5 lists the audio specifications, Figure 2-3 shows the audio connector, and Table 2-6 shows the audio connector pinouts.

Table 2-5 Audio Interface Specifications

Mono microphone input	Stereo Line Input
Mono speaker output	Stereo Line Out
CODEC	Crystal CS4215 or Analog Devices AD1849
Sampling rate	Up to 48 KHz

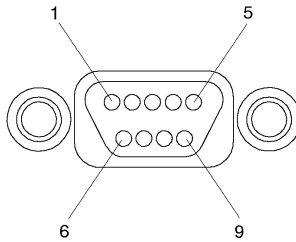

Figure 2-3 Audio Connector

Table 2-6 Audio Connector Pinouts

Pin No.	Signal
1	Mic GND
2	Headset right
3	Microphone B
4	Line-in left
5	Headset left
6	Not used
7	Line-in right
8	Microphone A
9	Not used

HP Parallel

The parallel port is compatible with the Centronics® interface as implemented by Hewlett-Packard. It supports a bi-directional register model interface. An 8-bit parallel, synchronous interface is used. The Series 700 Scanjet interfaces are not supported.

A high density micro D-sub connector is used for the HP Parallel interface. An HP A4300A conversion cable is required to convert to standard PC compatible 25-pin female D-sub.

Table 2-7 lists the technical information for the HP Parallel interface.

Table 2-7 HP Parallel Interface Specifications

Type:	Centronics® and BUSY handshakes
Data Rate:	>300 Kbytes/second with DMA 200 Kbytes/second sustained.
Device Limit:	1
Connector Type:	female 25-pin micro D-sub

Figure 2-4 shows the HP parallel connector.

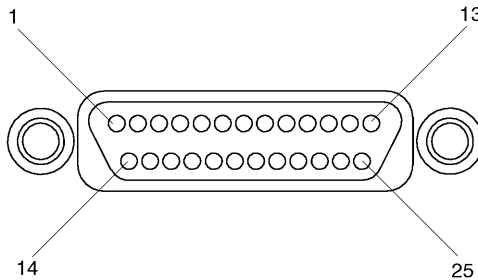

Figure 2-4 HP Parallel Connector

Functional Description

Built-in Interfaces

Table 2-8 shows the connector pinouts for the HP parallel connector.

Table 2-8 HP Parallel Connector Pinouts

Pin Number	Signal	Pin Number		Pin Number	
1	NSTROBE	10	NACK	19	GND
2	Data 0	11	BUSY	20	GND
3	Data 1	12	PE	21	GND
4	Data 2	13	SLCT	22	GNDGND
5	Data 4	14	NAFD	23	GND
6	Data 4	15	NERROR	24	GND
7	Data 5	16	NINIT	25	GND
8	Data 6	17	NSCT IN		
9	Data 7	18	GND		

RS-232 Ports

There are two RS-232-C serial interfaces. This standard interface is based on a 9-pin D-sub connector and supports CTS/RTS hardware handshaking. This port is based on the National 16550 serial interface chip. Serial Port B is not functional until VME Services software is loaded and operating.

The serial ports use a high density connector. An HP A4301A conversion cable is required to convert it to a standard PC compatible, 9 pin male D-sub. The maximum baud rate listed is the hardware limit. Actual transfer rates depend upon the operating system and application load. Table 2-9 shows the RS-232-C Specifications.

Table 2-9 RS-232-C Specifications

Type:	EIA RS-232-C, CCITT V.24/V.28
Baud Rate:	50 to 460.8 Kbits
Word size:	5 to 8 bits

Table 2-9 RS-232-C Specifications

Parity:	Odd, even, none, one, zero
Stop bits:	1, 1.5, 2
Connector Type:	9-pin female micro D-sub
Controller:	16550 UART compatible megacell

Figure 2-5 shows the RS-232 serial connector.

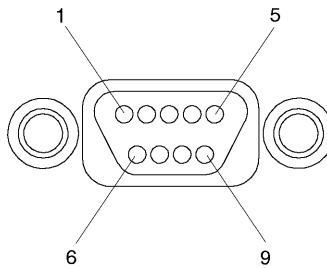

Figure 2-5 RS-232 Serial Connector

Table 2-10 shows the RS-232-C connector pinouts.

Table 2-10 RS-232-C Connector Pinouts

Pin No.	Signal	Pin No.	Signal
1	DCD	7	RTS
2	RXD	8	CTS
3	TXD	9	RI
4	DTR		
5	GND		
6	DSR		

AUI LAN

LAN circuits use the Ethernet/IEEE 802.3 standard interface. Only the Attachment Unit Interface (AUI) version is used; no BNC connector is provided for ThinLAN. The shared memory area has the memory controller circuits, 16 Kbytes of RAM, 64 nybbles of non-volatile storage of the node address, and control, status, and ID registers. Multiplexing of CPU bus information and the LAN chip set is also part of the controller circuit.

Frontplane circuits include the LAN chip set, timer, and the transceiver chip. The LAN chip set serves the dual function of a DMA controller and an Ethernet/IEEE 802.3 controller. Encoded data from the serial interface adaptor (SIA) is transmitted by the transceiver chip. Data from the network is sent by the transceiver chip to the SIA. The AUI connector enables connections to an external MAU. Figure 2-6 shows the AUI LAN connector and Table 2-11 shows the LAN connector pinouts.

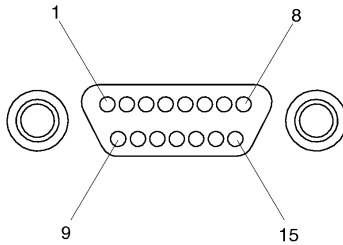

Figure 2-6 AUI LAN Connector

Table 2-11 AUI LAN Connector Pinouts

Pin No.	Signal	Pin No,	Signal
1	GND	9	CI-B
2	CI-A	10	DO-B
3	DO-A	11	DO-S (GND)
4	DI-S (GND)	12	DI-B
5	DI-A	13	+12V
6	GND	14	GND
7	CO-A (NC)	15	CO-B (NC)
8	CO-S (NC)		

SCSI

The built-in SCSI-2 port is implemented using an NCR710 macrocell inside the I/O ASIC chip. This 8-bit single ended implementation is compatible with the current Series 700 products and supports 5 Mbytes/sec data transfer rates.

The SCSI bus is terminated to 3.3 volts through 127 Ohms. on the system board. If the board computer is used in a VMEbus chassis having internal mass storage devices, those devices must have their terminator removed. If an external disk drive is used, an active terminator must be used on the last drive's uncabled connector.

Table 2-12 shows the SCSI interface specifications.

Table 2-12 SCSI Interface Specifications

Type:	SCSI-II (ANSI x3.131-1986), 8-bit, single-ended
Data Rate:	Synchronous - 5MBytes/second
Device Limits:	7 internal and/or external peripherals Note: The CPU is considered one device.
Connector Type:	SCSI-II, ALT-1 50-pin high-density thumbscrew
Maximum External Cable Length:	4 meters (13.1 feet)
Controller:	NCR 53C710 compatible macrocell, Rev. D.

Figure 2-7 shows the SCSI connector.

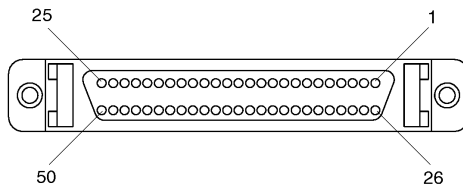

Figure 2-7

SCSI Connector

Functional Description
Built-in Interfaces

Table 2-13 shows the SCSI connector pinouts.

Table 2-13 SCSI Connector Pinouts

Pin Number	Signal	Pin Number	Signal	Pin Number	Signal
1	GND	21	GND	41	ATN
2	GND	22	GND	42	GND
3	GND	23	GND	43	BSY
4	GND	24	GND	44	ACK
5	GND	25	GND	45	RST
6	GND	26	DATA 0	46	MSG
7	GND	27	DATA	47	SEL
8	GND	28	DATA 2	48	CND
9	GND	29	DATA 3	49	REQ
10	GND	30	DATA 4	50	INO
11	GND	31	DATA 5		
12	GND	32	DATA 6		
13	NC	33	DATA 7		
14	GND	34	Data Parity		
15	GND	35	GND		
16	GND	36	GND		
17	GND	37	GND		
18	GND	38	+5		
19	GND	39	GND		
20	GND	40	GND		

PS/2 Ports 1 and 0

There are two PS/2 style serial ports: one PS/2 keyboard port and one PS/2 mouse port. In the Boot Console Handler's hardware menu and on the front panel, they are listed as PS/2-0 (Kbd) and PS/2-1. Figure 2-8 shows the PS/2 connector.

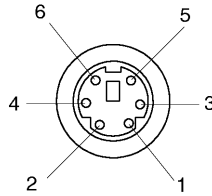

Figure 2-8 PS/2 Connector

Table 2-14 shows the PS/2 connector pinouts.

Table 2-14 PS/2 Connector Pinouts

Pin No.	Signal
1	Data
2	Not used
3	GND
4	+5
5	Clock
6	Not used

VME Controller ASIC

A VME controller ASIC manages the board computer's interface with the VMEbus back-plane it plugs into. In addition, the RS-232 interfaces are also controlled by the VME controller ASIC.

Table 2-15 and Table 2-16 list the VMEbus connector pinout information.

Table 2-15 VME P1/J1 Pin Assignments and Signal Mnemonics

Pin Number	Row A	Row B	Row C
1	D00	BBSY	D08
2	D01	BCLR	D09
3	D02	ACFAIL	D10
4	D03	BG0IN	D11
5	D04	BG0OUT	D12
6	D05	BG1IN	D13
7	D06	BG1OUT	D14
8	D07	BG2IN	D15
9	GROUND	BG2OUT	GROUND
10	SYSCLOCK	BG3IN	SYSFAIL
11	GND	BG3OUT	BERR
12	DS1	BR0	SYSRESET
13	DS0	BR1	LWORD
14	WRITE	BR2	AM5
15	GND	BR3	A23
16	DTACK	AM0	A22
17	GND	AM1	A21
18	AS	AM2	A20
19	GROUND	AM3	A19

Table 2-15 VME P1/J1 Pin Assignments and Signal Mnemonics

Pin Number	Row A	Row B	Row C
20	IACK	GROUND	A18
21	IACKIN	SERCLK(1)	A17
22	IACKOUT	SERDAT(1)	A16
23	AM4	GROUND	A15
24	A07	IRQ7	A14
25	A06	IRQ6	A13
26	A05	IRQ5	A12
27	A04	IRQ4	A11
28	A03	IRQ3	A10
29	A02	IRQ2	A09
30	A01	IRQ1	A08
31	-12 Vdc	+5 V STDBY	+12 Vdc
32	+5 Vdc	+5 Vdc	+5 Vdc

Table 2-16 shows the VME P2/J2 Pin assignments and signal mnemonics.

Table 2-16 VME P2/J2 Pin Assignments and Signal Mnemonics

Pin Number	Row A	Row B	Row C
1	User Defined	+5 Vdc	User Defined
2	User Defined	Ground	User Defined
3	User Defined	Reserved	User Defined
4	User Defined	A24	User Defined
5	User Defined	A25	User Defined
6	User Defined	A26	User Defined
7	User Defined	A27	User Defined
8	User Defined	A28	User Defined

Table 2-16 VME P2/J2 Pin Assignments and Signal Mnemonics

Pin Number	Row A	Row B	Row C
9	User Defined	A29	User Defined
10	User Defined	A30	User Defined
11	User Defined	A31	User Defined
12	User Defined	Ground	User Defined
13	User Defined	+5 Vdc	User Defined
14	User Defined	D16	User Defined
15	User Defined	D17	User Defined
16	User Defined	D18	User Defined
17	User Defined	D19	User Defined
18	User Defined	D20	User Defined
19	User Defined	D21	User Defined
20	User Defined	D22	User Defined
21	User Defined	D23	User Defined
22	User Defined	Ground	User Defined
23	User Defined	D24	User Defined
24	User Defined	D25	User Defined
25	User Defined	D26	User Defined
26	User Defined	D27	User Defined
27	User Defined	D28	User Defined
28	User Defined	D29	User Defined
29	User Defined	D30	User Defined
30	User Defined	D31	User Defined
31	User Defined	Ground	User Defined
32	User Defined	+5 Vdc	User Defined

Graphics Accessory Cards

Graphics accessory cards have the same circuits as on-board graphics.

Graphics cards supported on HP-UX and HP-RT operating systems include the HP A4267A 8-Plane Color Graphics Card, the HCRX8/VME, and the HCRX24/VME graphics cards.

The board computer can be configured using the Boot Console Handler in configuration mode for several graphics situations. Table 2-17 shows monitor resolution and refresh rates for installed on-board graphics and HP A4267A graphics cards.

Table 2-17 Supported Graphics Configurations

Display Pixel Resolution	Display Refresh Rate	Onboard Graphics	HP A4267A 8-Plane GSC Card	HP A4315A 8-Plane or HP A4316A 24-Plane HCRX Graphics
1280 x 1024	75 Hz 72 Hz	•	•	• •
1024 x 768	75 Hz 70 Hz	•	•	
800 x 600	75 Hz	•	•	
640 X 480	75 Hz 60 Hz	•	•	

RAM Cards

RAM cards supported on both HP-UX and HP-RT operating systems include:

- HP A4263A 8 Mbyte RAM Card
- HP A4264A 16 Mbyte RAM Card
- HP A4265A 32 Mbyte RAM Card
- HP A4266A 64 Mbyte RAM Card

RAM cards may be installed in any order. The memory mapping feature determines what size card is in each location during power-on. If errors are found during the memory tests, the system displays a chassis code. Table 2-18 lists the chassis code errors with the physical RAM slot they relate to.

See Chapter 5 for more information on Chassis Codes.

Table 2-18 **RAM Failure Chassis Codes vs. RAM Slot**

0x Code	RAM Slot
27100	RAM error, physical slot 0
27101	RAM error, physical slot 1
27102	RAM error, physical slot 2
27104	RAM error, physical slot 4

Battery Backed Real-Time Clock

The Model 743 uses a battery backed read-time clock. This section provides safety information for handling lithium batteries. This section also provides information on the timers used in the Model 743.

WARNING:

Lithium batteries can explode if mistreated. Do not put lithium batteries in fires or try to recharge or disassemble them. Replace lithium batteries only with Matsushita Electric BR-1616 three-volt lithium batteries (HP part number 1420-0525)! Use of any other battery can cause fire or explosion.

The battery-backed clock is implemented in the I/O controller ASIC. Once power is applied to the system board, the battery-backed clock time is read by the operating system only during system initialization. Once the operating system is booted, real time is kept using the timer built into the CPU. The battery-backed real-time clock is updated by the operating system only when the user explicitly requests it. Table 2-19 lists the Real-time clock specification.

Table 2-19 Real-Time Clock Specifications

Resolution:	1 second
Battery Type:	Lithium
Battery Life:	Power off: 6 months Power on, 10 years

Interval Timers

The VME Controller ASIC includes two interval timers and a watchdog timer. These timers provide interrupt on terminal count and interrupt and restart on terminal count capability. Table 2-20 lists the interval timer specifications.

Table 2-20 **Interval Timer Specifications**

Timer 1 Length	32 bits, cascadeable into timer 2
Timer 2 Length	16 bits, cascadeable into timer 3
Timer 3 Length	16 bits

Watchdog Timer

The VME controller ASIC also includes a watchdog timer. When enabled, the watchdog timer generates at service mode after 256 ms, if not reset by software. If the software does not reset it, then it generates a hardware reset.

Power Distribution

Power is distributed through the VMEbus chassis' P1 and P2 connectors to the Model 743 board computers PC boards:

- System board and RAM card power comes through the system board's P1 and P2 connectors.
- RAM cards get power through the RAM stack 1 and 2 dual connectors.
- Graphics cards get power through the adapter's (Expansion kit or HCRX graphics board) P1 and P2 connectors.

NOTE: VME P1 and P2 connectors use two or more pins to carry power or grounds to the board computer. Check the VME P1 and P2 pinout tables for exact pin identification for power and grounds.

Table 2-21 lists power requirements. Figure 2-9 shows power distribution.

Table 2-21 Model 743 Board Computer Power Requirements

Assembly	Model 743/64			Model 743/100		
	+5	-12	+12	+5	-12	+12
System board ^a	6.1A	0.1A	0.1A	7.5A	0.1A	0.1A
RAM Cards	0.2A	0	0	0.2A	0	0
On-board graphics	0.6A	0	0	0.75A	0	0
Graphics card, 8-bit	0.6A	0	0	0.75A	0	0

- a. No on-board graphics, RAM, or accessory cards.

Functional Description
Power Distribution

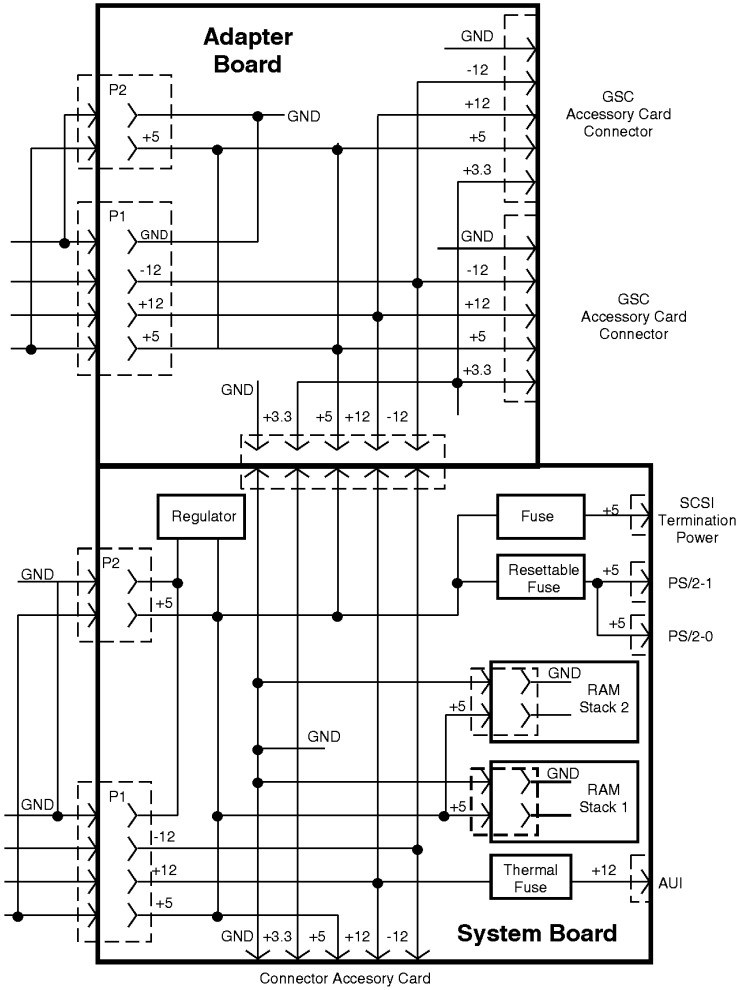

Figure 2-9 Power Distribution Diagram



Configuration

Introduction

This chapter provides detailed information on the various types of configurations available for the Model 743 board computer. This chapter provides step-by-step instructions for using the Boot Console handler, and information about graphics configuration.

Boot Console Handler

This section presents configuration capabilities of the Boot ROM, including:

- Using the Boot Console Handler
- Configuration Modes

Overview of the Boot Console Handler

The Boot ROM contains a micro-operating system called the Boot Console Handler (BCH). The Boot Console Handler is used to:

- Boot an application (usually ISL) from a specific device.
- Provide limited ability for a user to enter and save various kinds of configuration information in the EEPROMs.
- Display information about the hardware and firmware.
- Change/Configure automatic operations the Boot ROM code performs on boot.
- Locate hardware faults.

Most Boot Console Handler operations are performed by *selecting actions or data values* from a menu. Select menu items by typing a one or two digit number, then pressing the Enter/Return key, shown in step-by-step procedures as **Enter**.

The system can immediately perform simple configuration changes, such as changing the value of a path. More comprehensive changes, such as changing the attributes of a mode, require confirmation before they take effect, giving the user a chance to undo if necessary.

With the exceptions of the debugger environment and individual items in the system configuration menu, all user input consists of typing a one or two digit number and pressing the **Enter** key. In all menus, the names of the menu items and the prompt at the bottom of the menu provide information on how to proceed.

Using the Boot Console Handler

Perform the following steps to enter and use the boot console user interface:

- 1 Shut down your application.
- 2 Press the Rst/Abt switch on the front panel to the Rst (reset) position.

The system pauses, resets, then displays a screen similar to:

```
PDC - Processor Dependent Code - Version 300.0 release 0 (c)
Copyright 1994, Hewlett-Packard Company, All rights
-----
128 Mbytes of memory configured.      System Search started
Press [Esc] to discontinue the Auto Boot process
```

- 3 Press the Esc key to discontinue the autoboot process. The system displays a message stating the Auto Boot Process has been aborted, and then displays the Main Menu, as shown:

```
==== MAIN MENU =====
Key   Operation
-----
1   Boot From a Device
2   Path Configuration
3   Mode Configuration
4   Interactive Testing
5   Firmware Information
6   Hardware Information
7   System Configuration
...
77  Reset the system
88  Change Mode
99  Restart Auto Boot
-----
Press Key, then press [Enter/Return]
```

Main Menu

The Main Menu is the first menu in the menu hierarchy.

To select an item from the Main Menu, enter the associated key number and press Enter. For example, if you want to select Boot From a Device from the Main Menu, type:

```

1 Enter

==== MAIN MENU =====
Key  Operation
--  -----
1   Boot From a Device
2   Path Configuration
3   Mode Configuration
4   Interactive Testing
5   Firmware Information
6   Hardware Information
7   System Configuration
...
77  Reset the system
88  Change Mode
99  Restart Auto Boot
-----
Press Key, then press [Enter/Return]

```

Table 3-1 describes the key functions and operations that you can invoke from the Main Menu.

Table 3-1 Main Menu Options

Operation	Description
Boot From a Device	This menu lets you select a device from a list of present working devices in the current hardware configuration. The LAN interface lets other systems act as boot devices.
Path Configuration	The underlying menus show the devices currently specified for any of the device paths (primary boot, alternate boot, console or keyboard), and allow the user to choose a device to be remembered and used the next time the related search list is accessed. Paths are used to allow specific devices to be specified for use instead of just a device class. (see MODES).

Table 3-1 **Main Menu Options**

Operation	Description
Mode Configuration	The underlying menus lets you select a mode (see modes below) for use or to change and save any of a mode's attributes.
Interactive Testing	This menu item lets you execute individual optional tests or enter the debug environment.
Firmware Information	This menu item lets you display the revision information of the main ROM and the names and revision numbers for all extension ROMs.

Boot From a Device Menu

Access the **Boot From a Device** menu by entering the following from the Main Menu:

1 Enter

When you invoke the **Boot From a Device** menu item, the system displays a list of boot device categories. Which of these categories can actually be booted from depends on the system configuration:

```
==== BOOT DEVICE SELECT =====
PRIMARY PATH is now [ SCSI.6.0 ]
ALTERNATE PATH is now [ SCSI.5.0 ]
Key Operation
-----
 1 PCMCIA ATA 0
 2 PCMCIA ATA 1
 3 BPN
 4 LAN
 5 SCSI
 6 FWSCSI_1
 7 FWSCSI_2
 8 FWSCSI_3
 9 BPR
... ..
 0 Previous Menu
33 Effective ISL Mode [ AUTOMATIC ]
66 Auto Search for Boot Devices
77 Reset the System
88 Boot ALTERNATE PATH Device Now
99 Boot PRIMARY PATH Device Now
-----
Press Key, then press [Enter/Return] 0
```

To determine which bootable devices are available enter the following:

66 Enter

A list of devices similar to the following menu is displayed:

Configuration

Boot From a Device Menu

Scanning for Boot devices. Please wait...

==== BOOT FROM DEVICE =====

Key	Boot Device
1	SCSI.6.0 QUANTUM FIREBALL1050S
2	SCSI.5.0 QUANTUM FIREBALL1050S
3	LAN.15.20.93.16 INSTALL 15.20.93.16
4	LAN.15.20.88.47 INSTALL 15.20.88.47
5	LAN.15.20.88.100 INSTALL 15.20.88.100
6	LAN.15.20.88.96 INSTALL 15.20.88.96
7	LAN.15.20.92.249 INSTALL fibula
...
0	Previous Menu
33	Effective ISL Mode [AUTOMATIC]
66	Rescan for Boot devices
77	Reset the System

To boot from a device, Press Key, then press [Enter/Return]

Selecting a device from this menu causes an immediate attempt to boot a system from that device. A boot session begins when:

- System power is turned on.

- The reset switch is pressed.

- Following a transfer of control from an operating system.

The **Boot From a Device** menu is the only menu from which you can view systems which are capable of both installing software and from which you can boot in order to install operating system software. These are known as **INSTALL** systems.

The bottom portion of the **Boot From a Device** menu allows you to:

- Return to the previous menu (for example, the **Main Menu**).

- Change the effective ISL mode (**INTERACTIVE** or **AUTOMATIC**). This value is valid for the current Boot Console Handler (BCH) session only. Its initial value is determined by the current mode.

- Restart the search for bootable devices.

- Reset the system.

- Boot from Alternate or Primary Path device **NOW** (immediately on choosing one of these paths.)

Path Configuration Menu

The **Primary** and **Alternate Path** menus also performs a search for bootable devices. To access the Path Configuration menu, enter the following from the Main Menu:

2 Enter

The system displays the Path Configuration menu, as shown:

```
==== PATH CONFIGURATION =====
PRIMARY PATH is now [ SCSI.6.0 ]
ALTERNATE PATH is now [ LAN.090009-723333 ]
CONSOLE PATH is now [ RS-232 (A) ]
KEYBOARD PATH is now [ PS/2 (0) ]

Key Operation
-----
1 Primary Boot Path
2 Alternate Boot Path
3 Console Path
4 Keyboard Path
...
0 Previous Menu
77 Reset the System
-----
Press Key, then press [Enter/Return]
```

The Path Configuration menu shows the current values of the Primary, Alternate, Console and Keyboard paths and allows you to select which path to change.

Paths are used as a means of storing the address information of a specific device. This stored description may be used later to locate a bootable device, a console or a keyboard. The names of these paths may be thought of as the names of areas in the system EEPROM used to store information needed by programs to locate a specific device.

Table 3-2 lists the paths recognized by the firmware.

Table 3-2 Paths for Booting and Human Interfaces

Path Name	Name
Primary Path	A bootable device
Alternate Path	A bootable device
Console Path	A graphics monitor or RS-232 interface
KEYBOARD PATH	A keyboard interface

Interfaces used for booting, such as SCSI or LAN may have multiple devices attached. If you plan to consistently boot your system from a specific device, you should choose that device as the Primary Path.

Paths in this menu define either the location of a bootable device (Primary or Alternate) or the type of connector to be used for other devices (Console: video or RS-232, Keyboard: PS/2 0 or 1, HIL.)

NOTE: HIL devices are obsolete and no longer shipped.

Only one Console or Keyboard path can be attached to an interface.

The bottom section of the menu allows you to:

- Return to the previous menu

- Reset the system

Primary or Alternate Path Menus

Selecting a device from this menu causes the system to search for devices in that path. When they are found, they are displayed in a numbered list. From that list you can choose the preferred boot device for the Primary and/or Alternate device.

The bottom section of the menu allows you to:

- Return to the previous menu

- Repeat the search for bootable devices (rescan)

- Reset the system

Console Path Menu

Choosing this menu causes the system to interrogate the hardware then present a numbered list from which to choose the preferred Console connection. It may be a graphics connection, an RS-232 connection or NO connection (Null device.)

If you choose an RS-232 device, a new menu appears, allowing you to set various functional attributes such as baud rate.

For graphics interfaces which can support multiple monitor types, a new menu appears prompting you to select the correct monitor type you have connected to the system.

The bottom section of the menu allows you to:

- Return to the previous menu
- Repeat the search for console devices
- Reset the system

Keyboard Path Menu

Selecting this menu causes a scan for attached keyboards. A numbered list is presented showing ports where a keyboard is attached. You choose which keyboard you will use by typing in the number opposite the preferred port and pressing Enter. Only one keyboard can be chosen.

The bottom section of the menu allows you to:

- Return to the previous menu
- Repeat the search for keyboard devices
- Reset the system

Mode Configuration Menu

The values of a set of attributes which control how the Boot ROM behaves is called a MODE.

The five categories of attributes are:

- A list of paths and interfaces to use to find a boot device
- A list of a paths and interfaces to use to find a console device
- A list of a paths and interfaces to use to find a keyboard
- A list of optional selftests to execute
- A set of control flags

The values of all these attributes are stored in the 743's EEPROMs.

To access the Mode Configuration menu, enter the following from the Main Menu:

3 Enter

The system displays the **MODE CONFIGURATION** menu, as shown:

```
==== MODE CONFIGURATION =====
Mode is now [ USER ].

Key  Edited  Mode Attribute Class
-----
1           Boot Search Control
2           Console Search Control
3           Keyboard Search Control
4           Test Configuration
5           Control Flags
.....
0 Previous Menu
44 Set Mode Default Values
77 Reset the System
66 Cancel ALL changes
-----
To edit Mode Attributes, press Key, then press [Enter/Return]
```

There are up to three mode configurations stored in EEPROM: TEST, USER and OEM. The menus in Mode Configuration allow you to change the values of all the Mode attributes and store them in the appropriate EEPROM.

The mode named in the "Mode is now [...]" line of the Mode Configuration menu is the name of the set of values *currently in effect* that will be used when the system is reset or powered on. Each value set has factory defaults which can NOT be changed.

Config (Emergency) Mode

A feature in the Boot ROM called *Config Mode* or *Emergency Mode* is invoked by holding the Rst/Abt switch in the `Abt` (abort) position when the power is turned on. There is no EEPROM storage associated with this mode. The purpose of this feature is to allow a user to recover from inconsistencies between attribute values of the current mode governing console selection and the actual, currently available hardware.

For example, the system is configured to use the USER MODE values and those values specify that only RS-232 port A is to be used as a console. The system is now moved to a location where there is no RS-232 type terminal available but a GRAPHICS monitor and keyboard are provided. When Config mode is invoked, by holding down the Rst/Abt switch during power-on, the Boot ROM will behave as if the Interactive Console Search control flag is set to YES.

This means the system will not attempt to boot but will ask you to interact with it and designate the preferred Console Path by answering two prompts. The text of the first prompt is “Press 1 to select this console” this prompt will change in size reflecting changes in resolution; when the text of the prompt is clear and the size is what you want, press 1. Immediately the second prompt will appear. It’s text is “Press ESC to confirm” you must press the Esc key promptly because there is a short time-out to this prompt. The system now accepts the monitor and the keyboard you used as belonging to the Console Path and will correctly use them.

NOTE:

If you have more than one keyboard connected, the keyboard where you typed 1 to select Console automatically becomes the functioning keyboard. The additional keyboard is ignored and becomes non-functional.

After the Esc key has been pressed to confirm Console, the system automatically begins to boot.

Setting Values in the Mode Configuration Menu

The main part of the Mode Configuration menu allows the user to select which of the five sets of attribute values to change. A space labeled “Edited” between the Key number and the Attributes class name contains a YES if the value of the corresponding attribute has been changed by accessing the other menus and altering values.

Configuration

Mode Configuration Menu

The bottom section of the menu allows a user to:

- Return to the previous menu
- Set the attribute values to the factory default values for the current mode
- Reset the system
- Change the current mode

If any attribute values have been changed since this menu was entered, the bottom section will only allow a user to:

- Set (factory) default values for the current mode
- Save all of the current attribute values
- Change all attribute values back to what they were before they were edited.

Mode Configuration Menu Selections

The Control menus and the Test Configuration menu are divided into two numbered lists, each item having a unique number. This allows the user to “swap” items back and forth between the lists by simply typing the desired number next to the item you want to swap and pressing Enter. To cancel any changes you have made, either swap the items back until they are in the order you want, or return to the previous menu (Mode Configuration) and choose Cancel All Changes from the bottom of the menu.

Boot Search Control

This menu is split into the Search Order list and the Available Module list. The Search Order list is used by the Boot ROM to locate a boot device. The names of the devices appear in the order in which they will be used. The Available Modules list displays paths and interfaces which may be moved to the upper section. Selecting an item in either of these two lists causes it to be moved to the last position in the other list *carrying its number with it*. This is useful for a quick change to the order of search during booting. For example, Primary Path is usually the first item on the Search Order List and Alternate Path is usually the second item. If you needed the Alternate Path to be first you type the number opposite Primary Path and press Enter, the Primary Path item and its number drop to the end of the Available Modules list. Alternate Path is now the first item on the Search Order list and will be the first place the system looks to boot from.

If you wanted to create your own Search Order list, you can select each item in turn from the Search Order list and move it to the Available Modules list. Then, one by one, in the order you want them to be, select the devices you want to be in the Search Order list and transfer them.

The bottom section of the menu allows a user to return to the previous menu (the Mode Configuration menu).

Console Search Control

The Console Search Control menu is split into two lists. The top section lists paths and interfaces the Boot ROM uses to locate a console device. The names appear in the order in which they will be used. The lower section lists paths and interfaces which may be moved to the upper section. Selecting an item in either of these two lists causes it to be moved to the last portion of the other list.

The bottom section of the menu allows a user to return to the previous menu (the Mode Configuration menu).

Keyboard Search Control

The menu here is split into two lists. The top section lists paths and interfaces the Boot ROM uses to locate a keyboard device. The names appear in the order in which they will be used. The lower section lists paths and interfaces which may be moved to the upper section. Selecting an item in either of the two lists causes it to be moved to the last portion of the other list.

The bottom section of the menu allows a user to return to the previous menu (the Mode Configuration menu).

Test Configuration

The menu is split into two sections or lists. The top section lists the names of the optional tests which will be executed when the Fast Boot parameter flag is set to NO.

Unlike the other list attributes of a mode, the order in which the names appear in the list is *not* significant. Execution order is controlled by a default priority associated with the test. This is because, in some cases, there is a required sequence in which tests must be executed if they are executed at all.

The lower section lists the name of tests which may be moved to the upper section. Selecting an item in either of the two lists causes it to be moved to the last portion of the other list.

The bottom section of the menu allows a user to return to the previous menu (the Mode Configuration menu).

Control Flags

The main part of this menu shows all of the control flag names and whether the flag is set or not. If the flag is set (YES) in the set column, the action controlled by the flag will happen at the appropriate time in Boot ROM operations. Table 3-3 lists the flags and their setting indications.

Table 3-3 Mode Configuration - Control Flags

Control	Setting Indications
Fast Boot	YES means that optional self-tests will not be executed and that tests on some interfaces and devices such as graphics will be minimized. Because HP-UX requires that console and all graphics devices be initialized before control is given to the OS, it is strongly recommended that Fast Boot be left at NO.
Secure Mode	YES means that console input will not be enabled.
Auto Boot Select	YES means that at power on or reset, an attempt will be made to locate and boot from a boot device.
Diagnostics to RS-232 (A)	YES means that chassis codes will be sent to the RS-232 (A) device. This device is initialized to operate at 9600 baud, 8 bits per byte and no parity. If this device is the console, the console should have the same operating parameters. (these are the default parameters for RS-232 console devices) If the console must be RS-232 port A and the parameters must be different (19200 baud, for example) then Diagnostics to RS-232 port A should not be enabled.
Error Logging	YES means that chassis codes will be sent to an OEM supplied routine. The supplied default routine returns without taking any action.
Interactive ISL	YES means that when ISL is executed, it will stop and ask for commands. NO means that when ISL is executed, it will attempt to execute the commands in the AUTO file.

Table 3-3 **Mode Configuration - Control Flags**

Control	Setting Indications
Repeat Scan for Auto Boot devices	YES means that if the attempt to locate a boot device fails, start at the beginning of the search list and try again. This process will continue indefinitely. NO means that if the attempt to locate a boot device fails, invoke the Boot Console Handler.
Interactive Console Search	YES means that at power up or reset, use the interactive console selection method to locate a console. NO means that the console and keyboard search lists will be used to locate a console device.

The bottom section of the menu allows a user to return to the previous menu (Mode Configuration menu).

Interactive Testing

This menu lets you run selected tests and access the debugger environment.

To access the Interactive Testing menu, enter the following from the Main Menu:

4 Enter

The system displays the Interactive Testing menu, as shown:

```
==== INTERACTIVE TESTING =====  
Key  Operation  
-----  
1  CPU S.S.  
2  HIL INIT  
3  GRAPHICS 1 INIT  
4  GRAPHICS 2 INIT  
5  GRAPHICS 3 INIT  
6  GRAPHICS 4 INIT  
  
... ..  
0  Previous Menu  
44 Enter Debug Environment  
77 Reset the System  
-----  
To run a test, Press Key, then press [Enter/Return]
```

Table 3-4 provides a description for the types of interactive tests available on the Model 743.

Table 3-4 **Interactive Tests**

Test	Description
CPU S.S.	Tests the CPU super scalar operations
HIL INIT	<p>Initializes and tests the HIL interface. This test supports the Model 748i VME system's HP-HIL connector used with its EISA converter board. If no HIL device is connected, the test reports FAILED. If an HIL device is connected and is not the Console device, the test reports PASSED.</p> <p>If HIL is the console keyboard, the test will not be run and the message "hardware in use" will be displayed.</p>
GRAPHICS <i>n</i>	<p>Initialize and tests the specified graphics(n) interface(1,2,3,4 whatever is installed in the system.)</p> <p>NOTE: If the hardware is missing, the test reports "Test not executed 'Hardware not present'." If the specified graphics interface is the console, the test will not run and "hardware in use" is reported.</p>

When an interactive test is run, the pass/fail message appears at the bottom of the menu as it scrolls up. For example, if you press Key 3 for the GRAPHICS 1 test, the system displays output similar to the following if the test passes:

Test Passed

When you press key 1, CPU S.S., the system displays the chassis code (0X004.108d), along with the pass/fail text, as shown:

0x004.108D Test Passed

Interactive Testing Limitations

The following list shows the limitations you should be aware of when performing interactive tests:

- Chassis codes will only be displayed for the CPU S. S. test.

- HIL and GRAPHICS tests will show either passed/failed or hardware busy/hardware missing messages.

- The console device used while running interactive tests will *not* be tested if selected. For example:

- A monitor is connected to the GRAPHICS 1 sub-system and you select the

Configuration

Interactive Testing

GRAPHICS 1 interactive test. The test will not be run on that graphics sub-system. That sub-system was tested at console selection time and if it is working, it will not be tested.

If the device is not physically present, the test will report “hardware not present.”

The bottom section of the menu allows you to:

- Return to the previous menu
- Enter the debug environment
- Reset the system

Accessing Firmware Information

This menu shows:

The revision number of the PDC version.

The revision numbers of the main hardware ROMs.

The revision numbers of the extension ROMs

This data on this menu gives an indication of what capabilities are present and what I/O interfaces the firmware can work with. Option socket resident extension ROMs will be shown last. Use this menu to determine what versions your system has.

To access the Firmware Information menu from the Main Menu, enter the following:

5 Enter

The system displays the Firmware Information, as shown:

```
==== FIRMWARE INFORMATION =====
PDC Version 307.2 Release 1 Extension ROMs
Name         Revision      Name         Revision
-----
CPU           1.00      MIOC         1.00
CACHE        1.00      RAM          1.00
Misc I/O     1.00      MSGS (Eng)   1.01
VME          1.02      EISA         1.02
PCMCIA ATA   2.00      ISA          1.00
BPN          2.00      RS-232       1.01
LAN          2.00      SCSI         2.00
PS/2        2.00      HIL         1.00
GRAPHICS    2.00      Null device  1.00
FW SCSI     2.20      GSC         1.10
BPR         1.00      PCI         1.00
PMC         1.00

Key  Operation
...  .....
  0  Previous Menu
 77  Reset the System
-----
Press Key, then press [Enter/Return]
```

The bottom section of the menu allows you to:

- Return to the previous menu
- Reset the system

Firmware revisions in ROMs are listed. Table 3-5 lists ROM identifications.

Table 3-5 Firmware Information ROM Identification

Menu Listing	ROM Description
CPU	ROMs in CPU
CACHE	Cache ROM
Misc I/O	Miscellaneous I/O ROM
VME	VME ROM
BPN	Backplane Networking ROM
LAN	LAN ROM
PS/2	Keyboard/Mouse ROM
GRAPHICS	Graphics ASIC ROM
FORTH	Forth ROM
MIOC	CPU Memory-I.O Controller
RAM	ROM in CPU
MSGs (Eng)	Language ROM
EISA	EISA Controller
RS-232	Serial ROM
SCSI	SCSI ROM
HIL	HP-HIL ROM
FW SCSI	FWSCSI ROM
PCI	PCI Tray ROM
PMC	PMC Bridge/Expander ROM
GSC	GSC Expansion Card ROM
PCMCIA ATA	PCMCIA ROM
BPR	Backplane ROM

Hardware Information

This menu displays the hardware components currently in the system in a hierarchical manner. The header part of the menu shows the model name, system board serial number and the cache sizes.

The main part of the menu gives a CPU description, RAM size, interfaces and ASICs which are on the same bus as the CPU. The built in LAN interface station address is shown under the I/O ASIC menu.

The Hardware Information menu displays the following:

- Model name
- System board serial number
- Cache size and the amount of available RAM
- Name and revision number of major ICs
- All interfaces currently configured in the system.

To access the Hardware Information menu, enter the following from the Main Menu:

6 Enter

The system displays the Hardware Information menu, as shown:

```
==== HARDWARE INFORMATION =====
Computer Model          9000/743
System Board Serial No. 40SM9J0259
Cache Size              128 Kbytes 128 Kbytes

Key  Component          Description
---  -
      CPU                Rev. 2.4, Freq. 64 MHz
      RAM                32 Mbytes
      1 I/O ASIC
      2 VME ASIC         Rev. 4
      3 VME
      4 ISA
      5 GRAPHICS 1
      PCI ASIC 2        Rev. 1

Key  Operation
...  .....
      0 Previous Menu
      77 Reset the System
-----
Press Key, then press [Enter/Return]
```

The bottom section of the menu allows you to:

- Return to the previous menu
- Reset the system

ASIC Hardware Component Information

ASIC items have hardware component menus that can be seen by pressing the corresponding key.

To view the I/O ASIC Hardware Component menu, enter the following from the Hardware Information menu:

1 Enter

The system displays the Hardware Component Info screen, as shown:

```
==== HARDWARE COMPONENT INFO =====
I/O ASIC

  AUDIO
  HP PARALLEL
  RS-232 (A)
  LAN 080009-8C8641
  SCSI
  PS/2 (0)
  PS/2 (1)

Key  Operation
...  .....
  0  Previous Menu
  77 Reset the System
-----
Press Key, then press [Enter/Return]
```

To view the VME ASIC Hardware Component Info screen, enter the following from the Hardware Information menu:

2 Enter

```
==== HARDWARE COMPONENT INFO =====
VME ASIC      Rev. 4

  BPN 080009-000000
  RS-232 (B)
  BPR 080009-000000

Key  Operation
...  .....
  0  Previous Menu
  77 Reset the System
-----
Press Key, then press [Enter/Return]
```

Graphics Information

The Hardware Information menu shows the locations of the graphics hardware, indicated by GRAPHICS 1, 2, and 3. The identifying number may change depending on the system board type and graphics accessory cards installed. (see: Graphics Configuration in this chapter.)

System Configuration Menu

This menu allows configuration information to be entered which does not lend itself to menu operations. As a general rule, considerable knowledge about the system is required before proper values can be entered here. The exact format and value limits of data entered here is particular to what is being configured.

WARNING: Use this menu for BPN and BPR support ONLY after you have consulted with HP Support Services

The only HP supplied entries here are BPN (Back Plane Networking) Configuration and BPR (Backplane ROM) Configuration.

```
==== SYSTEM CONFIGURATION =====
Key  Operation
-----
1    BPN configuration
2    BPR configuration

...
0    Previous Menu
77   Reset the System
-----
Press Key, then press [Enter/Return]
```

1 Pressing **1** Enter puts the following BPN submenu on the screen:

```
CPU No.          0
Anchor           0x00200000
AM code          0x30
value examples: 0 0x00200000 0x30
Type vluе(s), then press [Enter/Return]
```

The general sequence of operations in this menu is:

- 2 Type **1** to choose BPN configuration.
- 3 Type the data (CPU data, Anchor and AM code are typed in as one line, as indicated by the “value examples: shown following “AM code.”
- 4 Press Enter to exit this menu.

There are 3 data values for BPN, separated by spaces. Values not entered are ignored. Values entered or shown with a “0x” prefix are hex numbers; otherwise they are decimal.

Configuration

System Configuration Menu

- 5 Typing **2** Enter at the SYSTEM CONFIGURATION MENU puts the following BPR submenu on the screen:

```
Current BPR configuration:
  VME address = 0x00000000
  AM code     = 0x00

values example: 0x12345678 0x0d
Type value(s), then press [Enter/Return]
```

The general sequence of operations in this menu is:

- 6 Type in the data (VME address, AM Code) as one line, as indicated by the "value example" listed below the "AM code" line.
- 7 Press Enter to exit this menu.

There are 2 data values for BPR, separated by spaces. Values not entered are ignored. Values entered or shown with a 0x prefix are hex numbers; otherwise they are decimal.

An arbitrary number of commands may be added to the debug environment. You can also add items to the firmware, hardware, and system configuration menus.

Graphics Configuration

System boards may or may not have on-board graphics. If your Model 743 does not have a graphics card, and the customer wants to run an application that requires graphics, either a 743 board computer with on-board graphics installed must be ordered to replace the original board, or graphics capability must be added to the system through the installation of the Expansion Kit or an HCRX graphics board. The Expansion Kit allows up to two HP A4267A graphics cards to be installed. The HCRX8 or HCRX24 board allows one HP A4267A card to be installed.

NOTE: HP-UX 10.0 or later must be installed to support three graphics displays. HP-RT supports only one graphics display.

Graphics Information in Menus

Table 3-6 lists the graphics sub-system combinations with how their installed positions display in the Hardware Information Menu.

Table 3-6 Graphics Sub-System Combinations

Graphics Configuration	Boot Console Menu Label
743 Onboard graphics	GRAPHICS 1
(1)HP A4267A card (no on-board graphics)	GRAPHICS 1
(2)HP A4267A cards (no on-board graphics)	Left GSC connector, GRAPHICS 1 Middle GSC connector GRAPHICS 2
On-board graphics <i>and</i> (1) HP A4267A card	On-board graphics, GRAPHICS 1 HP A4267A card, GRAPHICS 2
On-board graphics <i>and</i> (2) HP A4267A cards	On-board graphics, GRAPHICS 1 Left GSC connector, GRAPHICS 2 Middle GSC connector, GRAPHICS 3
HCRX board (no on-board graphics)	GRAPHICS 1

Table 3-6 Graphics Sub-System Combinations

Graphics Configuration	Boot Console Menu Label
HCRX board <i>and</i> on-board graphics	On-board graphics, GRAPHICS 1 HCRX board, GRAPHICS 2
HCRX board <i>and</i> HP A4267A card (no on-board graphics)	HCRX board, GRAPHICS 1 HP A4267A card, GRAPHICS 2
HCRX board <i>and</i> HP A4267A card <i>and</i> on-board graphics	On-board graphics, GRAPHICS 1 HCRX board, GRAPHICS 2 HP A4267A card, GRAPHICS 3

To change or view the EEPROM graphics configurations:

- 1 Select Path Configuration from the Main menu by pressing:

2 Enter

The system displays the Path Configuration menu, as shown:

```

===== PATH CONFIGURATION =====
PRIMARY PATH is now [ SCSI.6.0 ]
ALTERNATE PATH is now [ LAN.090009-723333 ]
CONSOLE PATH is now [ RS-232 (A) ]
KEYBOARD PATH is now [ PS/2 (0) ]

Key Operation
-----
1 Primary Boot Path
2 Alternate Boot Path
3 Console Path
4 Keyboard Path
... ..

0 Previous Menu
77 Reset the System
-----
Press Key, then press [Enter/Return]

```

- 2 Select the Console Path menu by pressing **3 Enter**

The system displays a **Console Path** menu, similar to the following:

```
==== CONSOLE PATH =====
CONSOLE PATH is now [ GRAPHICS 1 ]
Key  Device Path
-----
  1  GRAPHICS 1
  2  RS-232 (A)
  3  Null Device
  4  RS-232 (B)
  ...
  0  Previous Menu
 66  Rescan for console devices
 77  Reset the System
-----
To set the CONSOLE PATH, Press Key, then press
[Enter/Return]
```

- 3 The Console Path menu lists the graphics as GRAPHICS 1, GRAPHICS 2, etc., up to the number installed in the system. To choose a specific resolution for the console monitor, press the key number opposite the graphics location where the monitor is connected. The Console Path Monitor Type menu displays. At the top of the menu, the current Console Path and its graphic connection is displayed as CONSOLE PATH is [GRAPHICS n] where “n” is the connector number.

```
==== CONSOLE PATH MONITOR TYPE =====
CONSOLE PATH is [ GRAPHICS 1 ] Type is Key 1
Key  Resolution      Hz Style
-----
  1  * 1280 by 1024  72
  2   1024 by  768  75
  3   1024 by  768  70
  4   1024 by  768  75 Flat Panel
  5   1280 by 1024  60
  6   1024 by  768  60
  7    640 by  480  60
  8   1280 by 1024  75 VESA
  9   1024 by  768  75 VESA
 10    800 by  600  75 VESA
 11    640 by  480  75 VESA
 12   1280 by 1024  72
 13   1280 by 1024  50
Key  Operation
...
55  SAVE any changes and goto Previous Menu
-----
To select a Type, press Key, then press [Enter/Return]
```

- 4 Enter the number for the desired graphics configuration.
- 5 Enter the following to save the changes and return to the previous menu:

5 5 Enter



Troubleshooting

Introduction to Troubleshooting

This chapter provides information about isolating a failing/failed component in a Model 743 board computer through the use of diagnostic tests and trouble shooting techniques. A failed component is traced to the level of the Field Replaceable Unit(FRU) and the FRU is replaced to correct a problem.

To troubleshoot a 743 you must be familiar with the HP-UX operating system and be able to start and stop processes. You should familiarize yourself with the various diagnostic software available and understand what the test results indicate.

Diagnostic Overview

Three types of diagnostics are available for the Model 743:

- **Selftests** are part of the Boot ROM code. They initialize and test the functional areas needed to boot the operating system.
- **Offline diagnostics** are on the Support Tape, a separate tape or CD-ROM media. They are ISL based.
- **Online diagnostics** are supplied with the operating system, but require the operating system to be booted.

ISL Environment

ISL provides the means to load the operating system. ISL also provides an offline platform to execute diagnostic and utility programs contained in the LIF volume on the boot device when the operating system is not loaded.

The ISL program is the first program loaded into main memory from an external media (LAN, disk, or tape) and launched by the initial program loader (IPL) routine from the Boot Administration environment.

The ISL environment provides the following capabilities:

- Execute user-entered commands to modify boot device paths and boot options in stable storage.
- Run offline diagnostic programs, as described later in this chapter.
- Provide automatic booting of the operating system after power-on or reset.

Boot ROM Selftests

Selftests are called by a bootstrap program resident in the Boot ROM. The Selftests initialize and test the board computer hardware needed to find and boot an operating system. I/O portions for the console and boot path are tested by the I/O Dependent Code (IODC) for each I/O function. Selftest runs from PDC I/O address space except for some portions of the cache test, which downloads itself to memory. Selftest code is not accessible for change by users.

Users have some control as to what tests are automatically executed at power-on or can manually gain access by pressing the Rst/Abt switch to the Rst (Reset) position. Users can also run specific Selftests using the Boot Console User Interface by pressing Esc when asked for during Normal Mode boot.

Selftests along with console and boot IODC verify that ISL/SYSBOOT can be loaded and run. In Normal Mode, all operations will stop if a test fails.

Boot ROM Selftests are run on the following circuits:

- CPU, floating-point and TLB

- I/O and memory controller

- VME I/O conversion

If the board computer is installed in a Model 748 VMEbus System, that system's EISA module will also be tested.

Since Selftests exercise key hardware parts, an error normally means the boot process stops. LED's indicate progress, status and errors. Selftest sequence, status and LED error codes are listed later in this section. A circuit is usually identified by the error and the field-replaceable unit having that circuit should be replaced.

The only performance limit is a reasonable amount of time is needed. From power-on to displaying the first console message for a 16-Mbyte installation is about 15 seconds. More memory requires a longer time.

Typical Selftest time without failures in Normal Mode with FASTBOOT, 32 Mbytes, is less than 8 seconds.

When the board computer first powers up, the CPU starts executing Boot ROM code. Before code is executed to boot an operating system, several things need to be set up and tested. The Boot ROM has several code segments to manage these responsibilities.

Hardware Initialization Support

Some hardware, such as video circuit initialization and floating RAM positioning, which can not wait for a system to be booted, must be initialized at power-up as soon as possible to prevent improper operation.

Go/No-Go Selftest Support

The primary objective is to tell the user that the board computer can boot the operating system. This consists of indicating which devices are present and reporting all detectable failures. Boot ROM Selftests are by no means guaranteed to handle all hardware failures correctly. Several things contribute to this, including current hardware design, limited code space and the fact that testing for unknown or unexperienced failures is virtually impossible.

Failure Indications

As the Selftest progresses, the LEDs display the current state. At the end of the test, a power-up with no errors is indicated by the green LED turned on and blinking and by immediate entry into the boot scanner.

If a failure occurred during the Selftests, then that failure will be indicated on the LEDs at the end of the tests. If there was more than one failure, the *highest priority failure* will be indicated on the LEDs. All the LED values are listed in Table 4-1.

The power-up Selftest runs automatically when the board computer is powered up. It calls a series of modules which test various parts of the board computer. The test modules run are:

- Early Selftest
- Read/Write Memory Test
- Read-only Memory Test
- Late Selftest

If an error occurs, an error code is displayed and execution halts. The following sections provide a description of the failure indications:

Early Selftest

The Early Selftest performs initialization and Selftest functions which do not require memory. It operates on the:

- CPU
- Cache memory
- Memory interface
- I/O interface

Read/Write Memory Test

The read/write memory test configures and tests the memory sub-system using both writes and reads.

Read-Only Memory Test

The read-only memory test configures and tests the memory sub-system using reads only.

Late Selftest

The late Selftest runs tests on functions which require memory or aren't needed to configure memory. It also "cleans up" after the Selftest, setting registers to values suitable for normal operation. The Late Selftest performs the following tests:

- Cache
- I/O bus interface

Extended Selftest

The purpose of the extended Selftest is to test those areas of the board computer which are not routinely tested by the power-up Selftest. This includes VMEbus, HP-IB, the real-time clock and timers.

The Boot Console User Interface is used to configure operation of the extended Selftest.

The extended Selftest tests these devices:

- Time of day clock (RTC)
- The three timers
- RS-232 ports A & B
- SCSI
- LAN
- Graphics, if installed
- HP-HIL
- HP-IB
- VMEbus
- HP Parallel

Firmware Selftest Failures

Two methods are used by the firmware to provide diagnostic information: the LEDs on the board computer's front panel and ASCII encoded chassis codes which are output through the RS-232 (A) port.

Interpreting the Front Panel LEDs

The Model 743 provides two LEDs, located to the left and right of the reset switch, as shown in Figure 4-1. The red LED is labeled SYSFAIL and the green LED is labeled POWER.

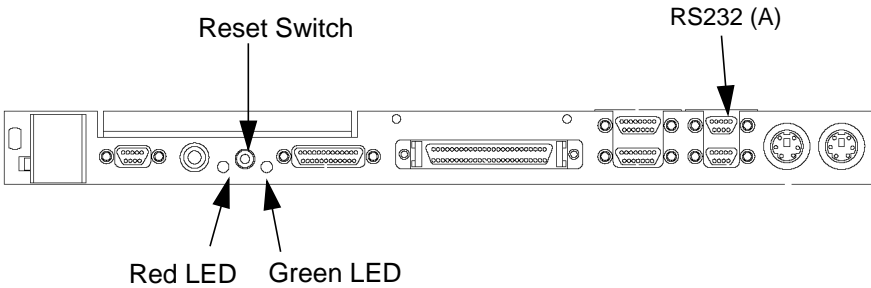

Figure 4-1 Model 743 LED Location

Table 4-1 provides information on interpreting the system status from the LEDs.

Table 4-1 LED Indicators

SYSFAIL (Red)	POWER (Green)	Meaning	Possible Solution
Off	Off	No Power	Check for board seating in chassis.
On	2Hz Flash	Normal Power-on/ selftest	If the system never proceeds past this point, either the console path is not set or there is a critical CPU failure. Refer to “Using the Emergency Interactive Console Search” in Chapter 3 to set the console path. If this fails, replace the system board.
On	Off	Memory Failure	Troubleshoot for failed RAM card or problem with the RAM connection.
On	1 Flash/ second	CPU (board) Failure	Replace the system board.
On	4 Flash/ second	No console identified	Check the console search path and keyboard connections. If no problem is found, replace the system board.
On	On	OS is booted with VME services failure	Check the Operating System VME services. Check that VME services is configured in the kernel.
Off	On	OS is booted with VME services OK	

Boot Options

If the usual boot device (typically a disk) is not responding as it should, you must attempt to boot from the disk (or another boot device) by selecting it manually. You may also want to access the ISL or Interactive Testing capabilities of the system.

To access boot options, follow these steps:

- 1 Power off your board computer for a few seconds.
- 2 Turn the power back on.

The system displays the following:

```
PDC - Processor Dependent Code - Version 300.0 release
0 (c) Copyright 1994 Hewlett-Packard Company, All rights
-----
128 Mbytes of memory configured.

System Search started

Press [Esc] to discontinue the Auto Boot process
```

- 3 Press and hold the Esc key as soon as the screen appears.

The system displays the Main Menu, as shown:

```
==== MAIN MENU =====
Key  Operation
-----
1  Boot From a Device
2  Path Configuration
3  Mode Configuration
4  Interactive Testing
5  Firmware Information
6  Hardware Information
7  system Configuration
... ..
77 Reset the system
88 Change Mode
99 Restart Auto Boot
-----
Press Key, then press [Enter/Return]
```

4 From the Main Menu, enter the following to select Boot From a Device:

1 Enter

When you invoke the **Boot From a Device** menu item, the system displays a list of boot device categories. Which of these categories can actually be booted from depends on the system configuration:

```
==== BOOT DEVICE SELECT =====
PRIMARY PATH is now [ SCSI.6.0 ]
ALTERNATE PATH is now [ SCSI.5.0 ]
Key  Operation
---  -
  1  PCMCIA ATA 0
  2  PCMCIA ATA 1
  3  BPN
  4  LAN
  5  SCSI
  6  FWSCSI_1
  7  FWSCSI_2
  8  FWSCSI_3
  9  BPR
...  .....
  0  Previous Menu
 33  Effective ISL Mode [ AUTOMATIC ]
 66  Auto Search for Boot Devices
 77  Reset the System
 88  Boot ALTERNATE PATH Device Now
 99  Boot PRIMARY PATH Device Now
-----
Press Key, then press [Enter/Return] 0
```

To determine which bootable devices are available enter the following:

66 Enter

A list of devices similar to the following menu is displayed:

Troubleshooting

Boot Options

Scanning for Boot devices. Please wait...

==== BOOT FROM DEVICE =====

Key	Boot Device
1	SCSI.6.0 QUANTUM FIREBALL1050S
2	SCSI.5.0 QUANTUM FIREBALL1050S
3	LAN.15.20.93.16 INSTALL 15.20.93.16
4	LAN.15.20.88.47 INSTALL 15.20.88.47
5	LAN.15.20.88.100 INSTALL 15.20.88.100
6	LAN.15.20.88.96 INSTALL 15.20.88.96
7	LAN.15.20.92.249 INSTALL fibula
...
0	Previous Menu
33	Effective ISL Mode [AUTOMATIC]
66	Rescan for Boot devices
77	Reset the System

To boot from a device, Press Key, then press [Enter/Return]

Selecting a device from this menu causes an immediate attempt to boot a system from that device. A boot session begins when:

- System power is turned on.

- The reset switch is pressed.

- Following a transfer of control from an operating system.

The **Boot From a Device** menu is the only menu from which you can view systems which are capable of both installing software and from which you can boot in order to install operating system software. These are known as INSTALL systems.

The bottom portion of the **Boot From a Device** menu allows you to:

- Return to the previous menu (for example, the Main Menu).

- Change the effective ISL mode (INTERACTIVE or AUTOMATIC). This value is valid for the current Boot Console Handler (BCH) session only. Its initial value is determined by the current mode.

- Restart the search for bootable devices.

- Reset the system.

- Boot from Alternate or Primary Path device NOW (immediately on choosing one of these paths.)

Interactive Testing Menu

Once in the Boot Console Handler Mode, at the Main Menu, select Interactive Tests. This menu, shown below, allows a user to run selected tests and allows access to the debugger environment. Table 4-2 lists the types of test you can run from the Interactive Test menu.

```

==== INTERACTIVE TESTING =====
Key  Operation
-----
1   CPU S.S.
2   HIL INIT
3   GRAPHICS 1 INIT
4   GRAPHICS 2 INIT
5   GRAPHICS 3 INIT
6   GRAPHICS 4 INIT
...
00  Previous Menu
44  Enter Debug Environment
77  Reset the System
-----
To run a test, Press Key, then press [Enter/Return]

```

Table 4-2 Interactive Tests

Test	Function
CPU S.S.	Tests the CPU super scalar operations
HIL INIT	Initializes and tests the HIL interface. This test support the Model 748i VME system's HP-HIL connector used with its EISA converter board. If this is the console keyboard, the test will not run, but will report "passed".
GRAPHICS <i>n</i>	If the hardware is missing, the test reports as "passed." If the special graphics interface is the console, the test will not run, but reports as "passed".

When an interactive test is run, the pass/fail message appears at the bottom of the menu. For more information and examples on Interactive Tests, see the section "Interactive Test Menu" in this manual.

Running ODE-Based Diagnostics

The Offline Diagnostic Environment (ODE) consists of diagnostic modules for testing and verifying system operation. ODE provides all the necessary functions for the user to load specified tests and interact with those tests.

ODE is an ISL utility. To boot ODE:

- 1 Invoke the ISL environment from the system disk.
- 2 Type **ode** after the ISL> prompt to invoke ODE from the LIF directory on the system disk. The prompt changes to ODE>.

Not all of the test modules are available on all systems. To see what test modules are available to run on this system, type **ls** at the ODE> prompt. The available modules include the following:

- **lasidiag** - tests and verifies the core-I/O functionality within the I/O ASIC chip. The diagnostics test the SCSI interface, LAN interface logic, parallel interface, audio, RS-232, PS/2 keyboard and mouse interface, real time clock, and the PC floppy interface and drive.
- **memtest** - tests and verifies the memory arrays. If an error is detected, the diagnostic reports the memory card that needs replacement and its slot number. Memtest also provides a map of the memory configuration so that the user can identify the type of memory and its slot location.
- **update** - updates the system's Processor Dependent Code (PDC) firmware on the EE-PROM.
- **mapper** - identifies the configuration of HPPA systems. It displays path, identification, and revision information of I/O components, configuration of memory controllers, processors, co-processors, cache, and TLB, as well as processor board component revisions and values of various HPPA system identifiers, revisions, and capabilities.

For further information on the various ODE commands and a complete listing of the command set, type **help** at the ODE> prompt or at the prompt of one of the test modules.

Determining the Faulty RAM Card

If a memory failure is detected during **memtest** execution, the failing memory card is indicated.

The following lists shows the location of the RAM stacks:

- RAM stack 1 is located behind the two PS/2 connectors on the board computer's right side.
- RAM stack 2 is on the other side behind the LEDs and Audio port.
- The low-number slot position is next to the system board.
- Note that a *maximum of three* RAM cards are supported in RAM stack 1 and only one RAM card is supported in RAM stack two.

Table 4-3 lists each RAM card location in each of the two RAM stacks.

Table 4-3

RAM Stack Cards

Physical Slot Number	Supported?
RAM Stack 2	
7	No
6	No
5	No
4	Yes
RAM Stack 1	
3	No
2	Yes
1	Yes
0	Yes

Running System Verification Tests

HP-UX uses an online diagnostics product called the Support Tools Manager that allows system operation verification. HP-RT does not support online diagnostics.

Three interfaces are available with the Support Tools Manager: a command line interface (accessed through the **cstm** command), a menu-driven interface (accessed through the **mstm** command), and the graphical user interface (accessed through the **xstm** command).

For more information on these user interfaces see the online man pages by entering the following at an hpterm command line prompt:

```
$ man cstm
```

```
$ man mstm
```

```
$ man xstm
```

For information on the enhanced online diagnostics, see the *Precision Architecture RISC HP 9000 Series 700 Diagnostics Manual*.

To access the Support Tools Manager, you must be logged in as “root” or “superuser”, and perform the following steps:

- 1 In a terminal window, type the following at the # prompt to invoke the command line interface:

```
# cstm
```

- 2 The following message appears:

```
Support Tool Manager Version A.01.00  
Type 'help' for a list of available commands:  
CSTM>
```

- 3 To verify the system operation, type the following at the CSTM> prompt:

```
CSTM> verify all
```

Messages similar to the following appear:

```
Verification has started on device (CPU).  
Verification has started on device (FPU).  
CSTM>Verification of (FPU) has completed.  
CSTM>Verification of (CPU) has completed.
```

- 4 Press Enter to return to the CTSM> after all test results are reported.
- 5 To exit the Support Tools Manager, enter the following:

```
CTSM> exit
```

If any tests failed, run Self Test and ISL diagnostics to isolate the problem.

Dealing with HPMC (Uncorrectable Error)

The power-on sequence follows this path:

Power-on -> Selftest -> Console Path -> Boot Admin Mode -> Boot Path -> ISL Mode -> Operating System Mode

When the hardware detects an unrecoverable (HPMC) error in the Operating System environment, an error message, referred to as a Kernel Tombstone is displayed on the monitor. The state of the system is written to main memory and the entire contents of main memory is dumped (written) to the swap area on the system disk.

HPMC error information is logged into Stable Storage; this information is referred to as PIM (Processor Internal Memory). The HPMC error information is available from the Boot Administration environment using the **PIM** command in the **Debug Environment** of the Interactive Testing menu.

An example of a PIM dump is:

```
----- Processor State Information (HPMC) -----
General Registers 0 - 31
00-07 00000000 15147165 FFFFFFFF FD79FFFF FF7EEBEF FF7E77FE 40480805 FFFFFFFBFF
08-0F 50000190 50560480 FFFFFFFF FFFFFFFF7 D7FFF3FF FDFBFF3 FFFFFFF7F FFFF3FF
10-17 180C4442 20280001 6FFBF6F FFFBDBD F7FFF5BF FEFFE6EF FFFFFFFD7 FEDDFFC
18-1F D4070342 05900040 FB6FEFF 7FFDDDFD 00000000 DF5DCFF 5FFBFEE F0013B2C

Control Registers 0 - 31
00-07 9F761EFC 00000000 00000000 00000000 00000000 00000000 00000000 00000000
08-0F 000FFFFF 000FFFFF 000000FF F25FEDEF 0000FFFF 0000FFE F9FDEF6F FFFFFFFF
10-17 3F51E640 000FABF BFFB33F 73F0A899 0000FFDF FFEF7EFF 00000000 ED144F4D
18-1F FFE7FFF FFFFFFFF FFFFAB FFFFFFFF BAAEFC2A FFF7F7F BFFFFFFF FFF7FFF

Space Registers 0 - 7
00-07 0000FFFD 0000FFFF 0000FFFF 0000FDFD 0000FFBF 0000FFFF 0000F7FD 0000FFFE

Other Processor Data
0000E6EE 7A708106 80000000 9E000004 00000000 40000000 00000000 00000000
00000000 00000000 00000000 00000000 00000000 00000000 00000002 FFFFFFFF
Assists Check Reserved Assist State System Resp System Req Path Info MIOC Status
```

Notice that data needed to interpret errors is in the field of "Other Processor Data". The data words needed in the following procedures are pointed out in the above example.

To identify the failed FRU(s) after an HPMC, follow these steps:

- 1 Examine the "Other Processor Data" words returned from the PIM command to display the latest error information from the last TOC, LPMC, or HPMC interruption detected.
- 2 Compare the values from the PIM command with those shown in Table 4-4 and take the appropriate action.

Table 4-4 PIM Action Table

Check Type Word	Cache Check Word	Bus Check Word	System Responder Word	Action
0x80000000	0x40000000	N/A	N/A	Replace CPU board
0x20000000	N/A	0x00210003	0x00000000 0xEFFFFFFF	Refer to Determining the Faulty Memory Card, later in this chapter.
0x20000000	N/A	0x00310007	0xF0000000 0xF01FFFFF	Replace CPU board.
0x20000000	N/A	0x00310007	0xF0200000 0xF0207FFF	Replace EISA tray, if present, or replace CPU board.
0x20000000	N/A	0x00310007	0xF0280000 0xF029FFFF	Replace PCMCIA adapter. If problem persists replace CPU board.
0x20000000	N/A	0x00310007	0xF0300000 0xF031FFFF	Replace CPU board.
0x20000000	N/A	0x00310007	0xF0400000 0xF3FFFFFFF	Check VME system configuration and/or replace CPU board.

Table 4-4 PIM Action Table

Check Type Word	Cache Check Word	Bus Check Word	System Responder Word	Action
0x20000000	N/A	0x00310007	0xF4000000 0xF5FFFFFF	Replace Graphics in GSC Slot 2, if present, otherwise check VME cards, and/or replace CPU board.
0x20000000	N/A	0x00310007	0xF6000000 0xF7FFFFFF	Check VME system configuration and/or replace CPU board.
0x20000000	N/A	0x00310007	0xF8000000 0xF9FFFFFF	Replace Graphics in GSC Slot 1, if present, otherwise check VME cards, and/or replace CPU board.
0x20000000	N/A	0x00310007	0xFA000000 0xFBFFFFFF	Check VME system configuration and/or replace CPU board.
0x20000000	N/A	0x00310007	0xFC000000 0xFFBFFFFFF	Replace EISA tray, if present, otherwise check VME system configuration, and/or replace CPU board.
0x20000000	N/A	0x00310007	0xFFC00000 0xFFD1FFFF	Replace CPU board
0x20000000	N/A	0x00310007	0xFFF80000 0xFFF83FFF	Replace optional GSC card in GSC Slot 1, if present, or replace CPU board.

Table 4-4 PIM Action Table

Check Type Word	Cache Check Word	Bus Check Word	System Responder Word	Action
0x20000000	N/A	0x00310007	0xFFF88000 0xFFF8BFFF	Replace optional GSC card in GSC Slot 2, if present, or replace CPU board.
0x20000000	N/A	0x00310007	0xFFF8C000F 0xFFFFFFFF	Replace CPU board

HPMC Caused by a Data Cache Parity Error

For example, an HPMC interruption is forced when a data cache parity error is detected during a load instruction to the memory address space or during a data cache flush operation.

Table 4-5 shows an example of the HPMC error information retrieved from Stable Storage by the PIM command from the Interactive Testing Debug Environment.

Table 4-5 Processor Module Error (Data Cache Parity)

Word	Value
Check Type	0x80000000
CPU State	0x9e000004
Cache Check	0x40000000
TLB Check	0x00000000
Bus Check	0x00000000
Assists Check	0x00000000
Assists State	0x00000000
System Responder Address	0x00000000
System Requester Address	0x00000000
System Controller Status	0x00000nnn

The value in the CPU State word indicates that register values and addresses stored in Stable Storage at the time of the HPMC were saved.

The value of the Cache Check word identifies that logic in the processor module detected a (data) cache parity error. Ignore the value in the System Controller Status word.

HPMC Caused by a Multi-Bit Memory Parity Error

An HPMC interruption is forced when a multi-bit memory parity error is detected during a “DMA read” operation or fetching an I/D cache line (32 bytes).

Table 4-6 shows an example of the HPMC error information retrieved from Stable Storage by the PIM command from the Interactive Testing Debug Environment.

Table 4-6 Multi-Bit Memory Parity Error

Word	Value
Check Type	0x20000000
CPU State	0x9e000004
Cache Check	0x00000000
TLB check	0x00000000
Bus Check	0x00210004
Assists Check	0x00000000
Assists State	0x00000000
System Responder Address	0xn timer
System Requester Address	0x00000000
System Controller Status	0x00000nnn

Interpreting the Table

The values in the Bus Check and System Responder Address words indicate that a multi-bit memory parity error was detected by logic in the memory module. Ignore the value in the System Controller Status word.

The System Responder contains the hexadecimal address of the faulty memory location. Read the following section, Determining the Faulty Memory Card, to determine which memory card contains the faulty memory location.

Determining the Faulty Memory Card

Memory is configured in a contiguous fashion starting at a base hexadecimal address of 0x00000000 to a maximum of 0x0FFFFFFF (256MB).

Memory is installed on the Model 743 in two stacks of up to four memory cards of 8MB, 16MB, 32MB, or 64MB capacity. The card on the bottom of Stack 1 is considered to be in physical slot 0, the second board in Stack 1 is physical slot 1, the third card is physical slot 2, and the card in Stack 2 is physical slot 4.

During the boot process the system maps from Slot 0 to Slot 4, in that order. To determine the failing memory card, you need to know the capacity of each memory card. The value of the System Responder Address corresponds to the memory ranges of each mapped memory card. Table 4-7 lists memory address ranges.

If the value of the System Responder Address is outside of the range of the installed memory cards, replace the CPU.

Table 4-7 Memory Address Ranges

Memory Range	Responder Address Range
0 - 16	0x00000000 - 0x00FFFFFF
16 - 32	0x01000000 - 0x01FFFFFF
32 - 48	0x02000000 - 0x02FFFFFF
48 - 64	0x03000000 - 0x03FFFFFF
64 - 80	0x04000000 - 0x04FFFFFF
80 - 96	0x05000000 - 0x05FFFFFF
96 - 112	0x06000000 - 0x06FFFFFF
112 - 128	0x07000000 - 0x07FFFFFF
128 - 144	0x08000000 - 0x08FFFFFF
144 - 160	0x09000000 - 0x09FFFFFF
160 - 176	0x0A000000 - 0x0AFFFFFF
176 - 192	0x0B000000 - 0x0BFFFFFF
192 - 208	0x0C000000 - 0x0CFFFFFF
208 - 224	0x0D000000 - 0x0DFFFFFF
224 - 240	0x0E000000 - 0x0EFFFFFF
240 - 256	0x0F000000 - 0x0FFFFFFF

Chassis Test Codes

This section provides information on interpreting chassis codes. It also provides a table which you can use to reference the chassis codes and the associated troubleshooting actions.

Introduction

Hexadecimal numbers are displayed during start up and other tests. These numbers represent tests and failures occurring in the board computer. Tables in this section list the chassis codes and their meanings.

When displayed, chassis codes are shown in this format:

0x41080

Use the tables in this section to find the chassis code. The tables do not include the “0x” prefix. Look up chassis codes by their numbers only, as shown:

41080

Interpreting Chassis Codes

When the board computer starts up, several chassis codes can be seen scrolling up from the display’s bottom. If the scrolling stops, perform the following steps:

- 1 Note the chassis code displayed at the bottom of the display.
- 2 Look up the chassis code in the chassis code tables, then find out what its function, test or error description is.
- 3 If a non-error description, or an error message is found, the field replaceable unit (FRU) that is indicated as processing that function should be replaced.

For example, if the scrolling chassis codes stop with 0x2408F at the bottom of the display, perform the following steps to troubleshoot the problem:

- 1 Find the chassis code section that has the 2408F chassis code.
- 2 Refer to the chassis code tables to find 2408F.
- 3 Read chassis code description for 2408F: ‘Co-processor fail,’ tells you the CPU chip’s co-processor has failed.

If a test or function chassis code stays at the display bottom and the board computer no longer functions, something is preventing the board computer from continuing.

- 4 In the `Replace` column, the system board is listed as the assembly to replace.

If the chassis code indicates a normal function or test, but the board computer is not continuing on with its process, the assembly listed in the `Replace` column should be replaced.

- 5 Replace the Model 743 system board to repair the board computer.

Chassis Code Terms

Table 4-8 shows the abbreviations used in the chassis codes.

Table 4-8 Chassis Code Terms

ALU	Arithmetic logic Unit
CPU	Central Processing Unit
DTLB	Data Translation Lookaside Buffer
FLT	Floating-Point Co-Processor
IODC	I/O Dependent code
IPL	Initialize Program Loader
HPMC	High Priority Machine Check
MIOC	Memory and I/O Controller, part of the CPU chip
PDC	Processor-Dependent Code
TLB	Translation Lookaside Buffer
TOC	Transfer of Control

Table 4-9 lists the chassis codes, the function, test, or error associated with the code, and solution.

Table 4-9 Chassis Codes

0x Code	Function, Test, or Error	Replace:
10000	Blank the display	System board
20000	RAM errors	RAM card
21000	Unexpected interrupt occurred during PDC execution	System board
210D7	MIOC SBE or DBE failure	System board
210D8	MIOC SBE or DBE failure	System board
22040	HPMC due to cache error	System board
22041	I-cache bad size	System board
22042	D-cache bad size	System board
22043	HPMC due to data cache error	System board
22044	HPMC due to I2 cache error	System board
22045	HPMC due to I1 cache error	System board
23003	Fatal error occurred writing to EEPROM	System board
2408F	Co-processor failure	System board
2503F	HPMC due to bus error	System board
27000	HPMC due to memory error	RAM card or system board
2707D	No RAM found	RAM cards or system board
27100	RAM error, physical slot 0	Slot 0 RAM card
27101	RAM error, physical slot 1	Slot 1 RAM card
27102	RAM error; physical slot 2	Slot 2 RAM card

Table 4-9 Chassis Codes

0x Code	Function, Test, or Error	Replace:
27104	RAM error; physical slot 4	Slot 3 RAM card
2C5F0	Primary IPL fatal fault	System board
2CBF0	HPMC handling initiated	System board
2CBFB	Branching to operating system HPMC handler	System board
2CBFF	Nested HPMC occurred (hanging the machine). Either a second HPMC occurred during a single boot or an HPMC occurred during TOC preparation.	System board
3FFFF	Blank with FLT	System board
41080	CPU diagnostics	System board
41081	CPU basic	System board
41082	CPU ALU branching	System board
41086	CPU bit operations	System board
41087	CPU arithmetic conditioner	System board
4108A	CPU arithmetic side effects	System board
4108B	CPU control registers	System board
4108C	CPU external interrupts	System board
41083	CPU shadow	System board
4108D	CPU super	System board
41090	TLB initialize	System board
41091	TLB address	System board
41092	TLB RAM	System board
41093	TLB replace	System board
41094	TLB protection	System board

Table 4-9 Chassis Codes

0x Code	Function, Test, or Error	Replace:
41095	Hardware TLB test	System board
41096	DTLB trap	System board
410D0	MIOC diagnostic	System board
410D1	MIOC interrupts	System board
410D2	MIOC HPMC	System board
410D3	MIOC transfer of control	System board
401D4	MIOC memory interface	System board
410D5	MIOC invalid address	System board
410D6	MIOC buffer and queue	System board
410D7	MIOC EDC single bit error	System board
401D8	MIOC EDC double bit error	System board
410D9	MIOC parity	System board
410DA	MIOC quick RAM test	System board or RAM card
401DB	MIOC normal RAM test	System board or RAM card
42090	Cache data lines	System board
42091	Cache address lines	System board
42092	I-cache RAM	System board
42093	D-cache RAM	System board
42094	Cache tag	System board
42095	Cache error	System board
42096	Cache configuration	System board
42097	Cache flush	System board

Table 4-9 Chassis Codes

0x Code	Function, Test, or Error	Replace:
42098	Cache byte	System board
42099	I-cache miss	System board
4209A	D-cache miss	System board
4209B	Cache done	System board
4209F	U-cache RAM	System board
43000	Start ROM checksum Selftest	System board
44080	Co-processor register	System board
44081	Co-processor instructions	System board
44082	Co-processor traps	System board
4707E	Non-destructive RAM	System board or RAM card
48000	I/O ASIC registers	System board
48003	Error reading IODC bytes	System board
48004	Error reading Entry INIT	System board
48005	Error executing Entry INIT	System board
48006	Error reading Entry IO	System board
48101	Core I/O module	System board
48102	LAN loopback	System board
48300	Entering I/O Selftest	System board
48301	Real Time Clock (I/O ASIC)	System board
48321	Built-in SCSI	System board
48322	Built-in LAN	System board
48324	Built-in RS-232	System board

Table 4-9 Chassis Codes

0x Code	Function, Test, or Error	Replace:
48326	Built-in HP Parallel	System board
48328	Built-in Audio	System board
4832B	Built-in PS/2 Port 0 (keyboard)	System board
4832C	Built-in PS/2 Port 1(mouse)	System board
48371	VME Backplane Networking	System board
483F0	Optional graphics ASIC	System board
483F1	On-board graphics ASIC	System board
483F5	EISA ASIC	Model 748 EISA controller
483F7	VME ASIC	System board
63001	Error reading from stable storage; contents invalid	System board
68007	Entry I/O error	System board
68008	Invalid device class	System board
6A008	No bootable device found	Mass storage
6C200	RAM configuration	System board or RAM card
6C20F	Forward progress indicator	System board
6C201	Starting RAM initializing destructively	System board or RAM card
6C202	Starting RAM initializing non-destructively	System board or RAM card
6C2EA	Starting initializing EISA subsystem	System board or Model 748 EISA controller

Table 4-9 Chassis Codes

0x Code	Function, Test, or Error	Replace:
6C2EB	Checking slots for EISA cards	System board or Model 748's EISA controller or back-plane
6C2EC	No configuration data for card in this slot	Card in Model 748's EISA slot
6C2ED	EISA card ID does not match ID in EEPROM configuration data	EISA card in Model 748
6C2EE	Error during card initialization	EISA card in Model 748
6C2Fn	<i>n</i> =slot number (1-4). Trying to initialize EISA card in Model 748 EISA, slot <i>n</i> : Chassis code: <ul style="list-style-type: none"> • 6C2E1 = slot 1 • 6C2E2 = slot 2 • 6C2E3 = slot 3 • 6C2E4 = slot 4 	EISA card in Model 748
6C2E0	Finished initializing Model 748's EISA sub-system	System board or Model 748's EISA board
6C400	Get stable storage console	System board
6C440	Initialize stable storage	System board
6C500	Get primary path	System board
6C540	Initialize primary path	System board
6C550	Test primary path	System board
6C580	Load IPL primary path	System board
6C5F0	Primary IPL fault	System board
6C5F1	Bad IPL primary address	System board

Table 4-9 Chassis Codes

0x Code	Function, Test, or Error	Replace:
6C5F2	Bad LIF magic primary	System board
6C5F3	Bad IPL primary size	System board
6C5F4	Bad IPL entry primary	System board
6C5F8	Bad IPL checksum primary	System board
6C5FF	Branching to IPL	System board
6C600	Get default console	System board
6C640	Initialize default console	System board
6C650	Initialize keyboard	System board
6C660	No keyboard	System board
6C750	Test other path	System board
6C700	Get manufacturing defaults	System board
6C780	Load IPL other path	System board
6C7F0	Other IPL fault	System board
6C7F1	Bad IPL other address	System board
6C7F2	Bad LIF magic other	System board
6C7F3	Bad IPL size other	System board
6C7F4	Bad IPL entry other	System board
6C7F8	Bad IPL checksum other	System board
6C7FF	Branching to other IPL	System board
6CB00	TOC handler entered	System board
6CB0B	Branching to operating system TOC handler	System board
6CD00	Initialize NIO	System board
AC900	Power fail pending	System board

Table 4-9 Chassis Codes

0x Code	Function, Test, or Error	Replace:
A3002	Error occurred writing to EEPROM	System board
CCA00	Power fail recover	System board



Field Replaceable Units

Introduction

This chapter lists the field replaceable parts for the HP 9000 Series 700i/rt Model 743i/rt VMEbus Board Computers. Components, including most of the ICs, are not available for field repair. The chapter includes information on the tools required to replace assemblies and safety precautions you should follow when replacing assemblies. It also provides instructions for accessing the board computer, system board, RAM cards, graphic cards, front panel, socketed ICS, and the real-time clock battery.

New Parts

You can order new parts directly from the following:

USA	Europe
Support Materials Organization Hewlett-Packard Company 8050 Foothills Boulevard Roseville, CA 95678 USA Telephone: (916) 786-8000	Parts Center Europe Hewlett-Packard GmbH Wolf-Hirth Strasse 33 D-7030 Boblingen, Germany Telephone: +41 7031 14-2253

Exchange Parts

Exchange parts are available for some items at a reduced cost. When an exchange part is ordered, your account will be charged for a new part. Place failed exchange parts in anti-static bags and package them securely in a sturdy container. It's a good idea to save the containers and static-free bags you receive parts in and use them to ship returned parts. Return failed exchange parts to your exchange parts source as soon as possible. Customers have 15 days to return the failed part to receive credit for the difference between a new and exchange part. Exchange only parts are available direct from the suppliers listed below:

USA	Europe
Support Materials Organization Hewlett-Packard Company 8050 Foothills Boulevard Roseville, CA 95678 USA Telephone: (916) 786-8000	Support material & Services Europe Hewlett-Packard Ltd. Filton Road - Stoke Gifford Bristol BS12 6QZ United Kingdom Telephone: +44 272 799910

Local Office Information

Use the following section to make note of your local Hewlett-Packard sales and service office for future reference.

Name:	
Address:	
City, State ZIP:	
Telephone:	

Replaceable Parts

Figure 5-1 highlights the major pieces of the Model 743 assembly, and Table 5-1 lists the part numbers of the Model 743 replaceable parts.

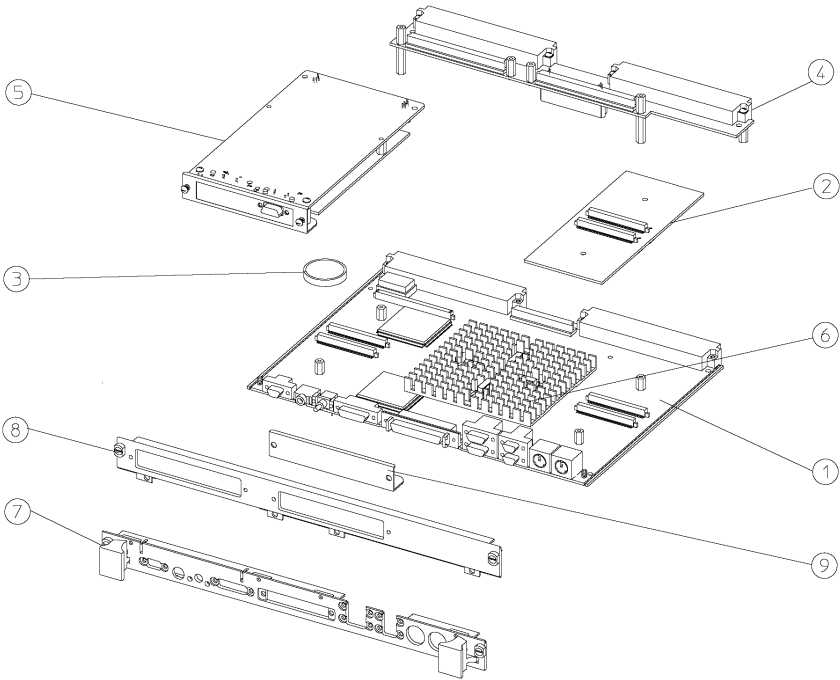

Figure 5-1 **Model 743 Board Computer Exploded View**

Table 5-1 Replaceable Parts

Callout Number	Description	Exchange Part Number	New Part Number
1	System board: 64 MHz (without on-board graphics)	A2636-69401	A2636-66001
	System board: 64 MHz (with on-board graphics)	A2636-69413	A2636-66013
	System board: 100 MHz (without on-board graphics)	A2636-69415	A2636-66015
	System board: 100 MHz (with on-board graphics)	A2636-69416	A2636-66016
2	8 Mbyte RAM card		A2636-66005
	16 Mbytes RAM card	A2636-69006	A2636-66006
	32 Mbyte RAM card	A2636-69007	A2636-69007
	64 Mbyte RAM card	A2636-69008	A2636-66008
3	Real-Time Clock Battery (See Warning)		1420-0525
not shown	PMC Bridge Adapter		A4504-60001
	PMC Expansion Adapter		A4504-60002
4	GSC Adapter		A2636-66012
5	GSC Graphics card; 8x8		A2636-66003
	GSC FWD SCSI card		A2969-60003
not shown	HCRX-8 Graphics card; 8x8		A4315-60001
	HCRX-24 Graphics card; 8x24		A4316-60001
6	CPU heatsink, foil, and clip		A2636-00011
7	Front panel		A2636-00001
8	Front panel extension		A2636-00002
9	Blank cover		A2636-00010

Table 5-1 **Replaceable Parts**

Callout Number	Description	Exchange Part Number	New Part Number
not shown	RS-232-C cable		A2636-61601
	LAN-AUI cable		A2636-61602
	Video cable		A2636-61603
	HP Parallel cable		A2636-61604
	Audio cable		A2636-61605
	EVC Monitor Video cable		A4500-62009

WARNING:

Replace battery only with Matsushita Electric BR-1616 three-volt lithium battery (HP part number 1420-0525)! Using any other battery can cause fire or explosion. Lithium batteries can explode if mistreated. Do not put lithium batteries in fires, try to recharge or disassemble them.

Tools Required and Preliminary Procedures

Tools Required for Assembly/Disassembly

All field replaceable parts can be accessed with these tools:

- Grounding wrist strap and static-free work place
- No. 1 Pozidriv screwdriver
- Small flat-tipped screwdriver
- 3mm (0.125-in.) thin-wall nutdriver, maximum outer diameter of 5.7mm (0.225-in.).
- Socketed surface-mount, 32-pin IC removal tool; AMP part number 821903-1, or equivalent.

Preliminary Procedures

Perform the following steps before any removal or replacement of a Field Replaceable Unit.

- 1 Exit application programs and shut down the computer.
- 2 Power off the VME chassis.
- 3 Remove all cables connected to the board computer.
- 4 Set up a static-free work place on which to work.

NOTE:

To reinstall a unit, set up a static-free work place and reverse the removal procedure.

Safety Precautions

It is essential to practice safety precautions when working with any electrical or electronic products. Following these safety precautions can help protect both you and the equipment from injury and possible permanent damage.

Whether the ICs are installed on a printed circuit board or laying on a table, integrated circuit components can be damaged by electro-static discharge. Static charges can build up in people to a potential of several thousand volts by simply walking across a room.

Protect integrated circuits by:

- Using a static free work place and wearing clothes that do not hold static charges before handling any of the workstation's PC boards.
- Unplugging the power supply before removing or installing a part.
- Touching sheet metal with your fingers before touching the printed circuit assembly.

If the assembly is not going to be re-installed, place the assembly in an anti-static bag and set it aside. Following these precautions extends the life of the computer products you maintain.

Removing and Replacing the 743 Board Computer

This section provides step-by-step instructions for removal and replacement of a single VME slot and dual VME slot 743 board computer.

Preliminary Requirements

Perform the following procedure before you remove the board computer from its VMEbus chassis:

- 1 Perform the steps in the Preliminary Procedures section of this chapter.

Removal

Follow these steps to remove the board computer from its VMEbus chassis:

- 1 Loosen the captive screws (labeled 1 and 2 in Figure 5-2) at each end of the board computer which hold the computer in the VMEbus chassis.
- 2 Raise both ejector levers outwards and pull the board computer forward out of the VME chassis.

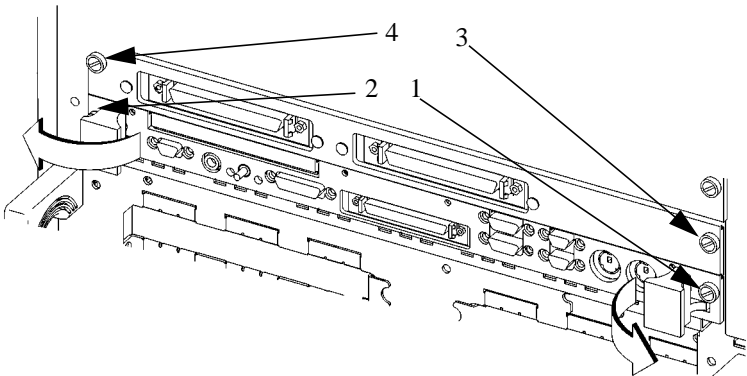

Figure 5-2 Captive Screws: Single and Dual Slot 743

Replacement

- 1** Loosen the captive screws (labeled 1 and 2, 3 and 4, in Figure 5-2) at each end of the board computer and the Extension panel.
- 2** Raise both ejector levers outwards and pull the board computer and extension out of the VMEbus chassis.

Replacing a 743 System Board

This section provides step-by-step instructions for replacing a system board.

NOTE:

If your 743 is configured as a dual VME slot computer, once the accessory boards, cards, any stacked RAM and Front Panel extension are removed the computer is in effect a single slot computer and can be dealt with as such for work on EEPROMs, PCMCIA (743rt only) and single RAM cards.

The Model 743 board computer's system board typically has one or more accessories attached. Remove the following accessories before returning a failed system board to Hewlett-Packard's board exchange program.

Single VME slot 743:

- RAM cards
- Front panel
- EEPROMs
- PCMCIA Adapter and Flash Disk card (743rt only)

Dual VME slot 743:

- RAM cards
- 3 x 5 GSC Cards
 - Graphics
 - FWD SCSI
- HCRX Graphics board *or* Expansion Kit adapter fixture
- EEPROMs
- PCMCIA Adapter and Flash Disk card (743rt only)
- Front panel and Front panel extension

Preliminary Requirements

Perform the following steps before replacing the system board:

- 1 Perform the steps in the Preliminary Procedures section of this chapter.
- 2 Remove the board computer from its VMEbus chassis (as explained in the "Removal and Replacement of the 743" section of this chapter.)

Field Replaceable Units

Replacing a 743 System Board

3 Follow the instructions in the remaining sections to remove the:

- RAM cards
- Graphics cards
- Adapter boards and fixtures
- Front panel and front panel extension
- Specific socketed ROMs

NOTE: Both the EEPROM and OEM ROM contain configuration information specific to the board computer's application. Both ROMs must be removed from the failed system board and re-installed in the replacement system board. The failed system board will then have the EEPROM that was on the new or exchange system board.

- 4 After removing all the accessories, place them on the new/exchange board and send in the failed board.
- 5 Reinstall the 743 in it's chassis. (Removing and Replacing the 743 Board Computer.)

CAUTION: When installing additional cards or replacing the CPU, always use the latest version BootROM available.

Removing and Replacing RAM Cards

This section provides step-by-step instructions for removing RAM cards from your Model 743.

Preliminary Requirements

Perform the following step before you remove a RAM card:

- 1 Remove the 743 from it's chassis. (Removing and Replacing the 743 Board Computer)

WARNING:

Be aware that older RAM cards (EDC# A-0201-SM) require gold colored spacers/standoffs under them. Newer RAM cards (EDC# A-0202-SM) require silver spacers/standoffs under them because of spacing differences inherent between old and new boards. Read the following section: Spacer/Standoffs carefully.

Spacer/Standoffs

When installing RAM cards (EDC# A-0202-SM) directly onto the CPU board:

- 1 If the existing CPU spacers are silver colored, install the RAM card and secure with the screws provided in the kit.
- 2 If the existing spacers are gold colored, remove the spacers and screws and set them aside. Replace the spacers and screws with the silver colored spacers and the screws from the kit.

When installing RAM cards (EDC# A-0202-SM) onto another RAM card, where the EDC# A-0202-SM will be the topmost card:

- 1 Remove and discard the screws from the topmost installed RAM card.
- 2 Install the silver colored spacers from the kit onto the topmost RAM card.
- 3 Install the EDC# A-0202-SM RAM card, (at this point it becomes the topmost RAM card) and secure it with the screws provided in the kit.

Removal

Follow these steps to remove RAM cards:

- 1 Remove the retaining screws from the uppermost RAM card as shown in Figure 5-3.

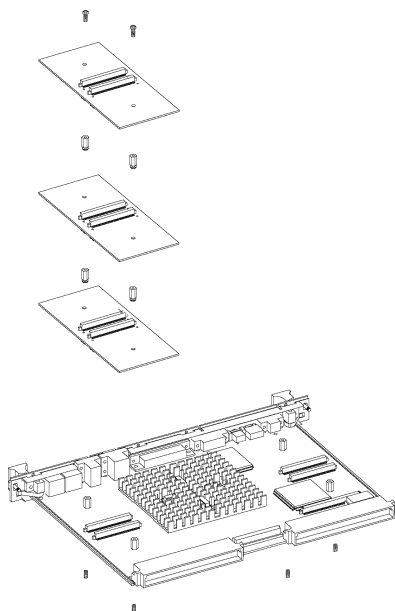

Figure 5-3 Retaining Screws and Standoffs

- 2 Pull the RAM card up and off the RAM stack or board computer.
- 3 Repeat the procedure for multiple RAM cards. The standoffs between cards act as retaining screws for the card below; remove them to access the card.

Replacement

- 1 To replace a card, remove the old card following the removal procedure.
- 2 Place the new card so the card is orientated the same way as the old card was.
- 3 Line up the connectors to match, then gently seat the card.
- 4 Replace the screws or standoffs used for that card.

Removing and Replacing GSC Cards

This section provides step-by-step instructions for removing GSC cards from your Model 743.

Preliminary Requirements

Perform the following steps before you remove a GSC card:

- 1 Remove the 743 from its chassis. (Removing and Replacing the 743 Board Computer, page 5-9)

Removal

Follow these steps to remove a GSC card:

- 1 Working from the back of the Model 743 Board Computer, the GSC graphics cards are in either the right-hand or center position shown in Figure 5-4.
- 2 Remove the two M2.5X5 screws that hold the card to the front panel extension plate.

Field Replaceable Units

Removing and Replacing GSC Cards

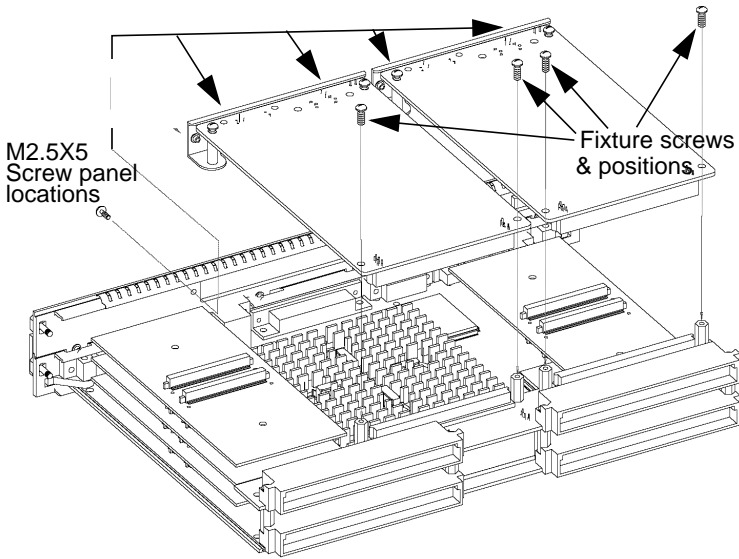

Figure 5-4 **GSC Fasteners**

- 3 Remove the two M2.5X6 screws which hold the GSC card to the adapter (Expansion Kit) fixture.
- 4 Remove the card by lifting it upwards out of the GSC connector.

Replacement

To replace the graphics card, reverse the steps in the procedure for removing a graphics card.

Removing and Replacing the GSC Adapter

This section provides step-by-step instructions for replacing the GSC adapter (Expansion Kit) in your Model 743.

Preliminary Requirements

Perform the following steps before removing the GSC adapter (Expansion Kit) from your Model 743:

- 1 Remove the 743 from its chassis. (Removing and Replacing the 743 Board Computer, page 5-9 .)
- 2 Remove any GSC cards. (Removing and Replacing GSC Graphics/FWD SCSI cards.)

Removal and Replacement

Follow these steps to remove the adapter from your Model 743:

- 1 Remove the two M2.5X6 screws from the bottom of the system board as shown in Figure 5-5.

Field Replaceable Units

Removing and Replacing the GSC Adapter

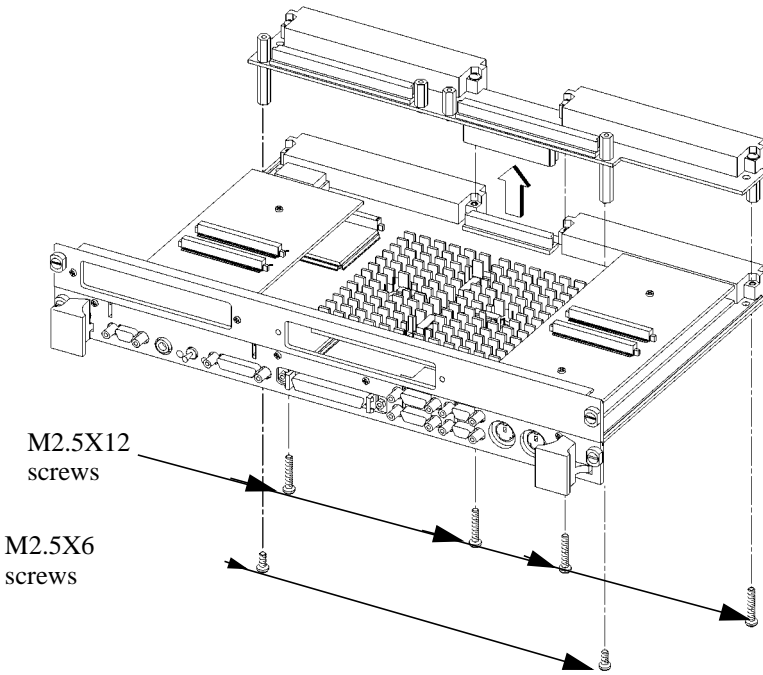

Figure 5-5 **Extension Adapter Fasteners**

- 2 Remove the four DIN connector M2.5X12 screws from the bottom of the system board.
- 3 Remove the adapter assembly from the system board by lifting straight up and disengaging it from the centered connector.

Removing and Replacing the PMC Adapters

This section provides step-by-step instructions for replacing the adapter (expansion kit) fixture in your Model 743.

Preliminary Requirements

Before removing the adapter (Expansion Kit) fixture from your Model 743, remove the Model 743 from its card cage. (See Removing and Replacing the Model 743 Board Computer, earlier in this chapter.)

Removal and Replacement

Follow these steps to remove the adapters from your Model 743:

- 1 Remove the ejector handle sleeve labels and springs, as shown in Figure 5-6.
- 2 Remove the ejector handle sleeves, as shown in Figure 5-7.
- 3 Remove the expansion adapter's two front panel screws, as shown in Figure 5-8.
- 4 Remove the expansion adapter's four VME connector screws, as shown in Figure 5-8.
- 5 Separate the expansion adapter from the bridge adapter.

Field Replaceable Units
Removing and Replacing the PMC Adapters

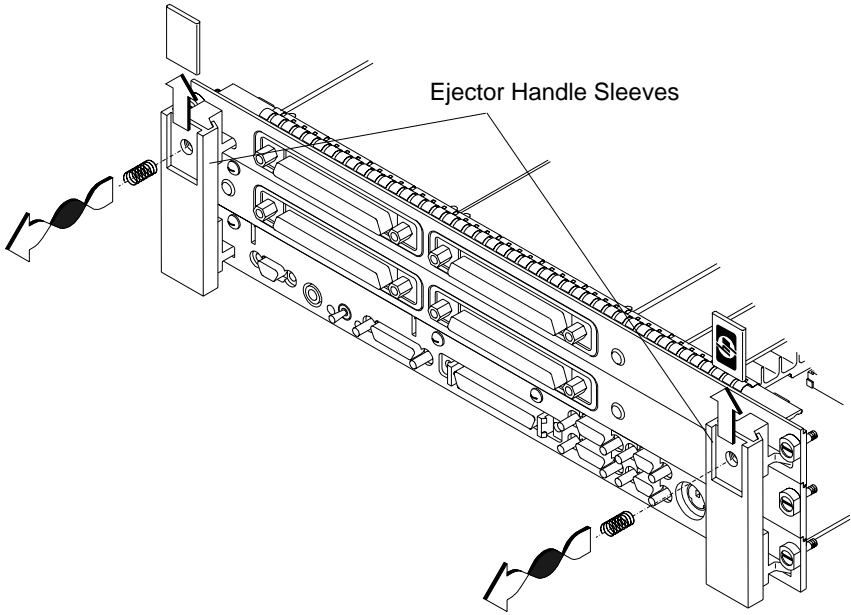

Figure 5-6 Removing the Labels and Springs

Field Replaceable Units
Removing and Replacing the PMC Adapters

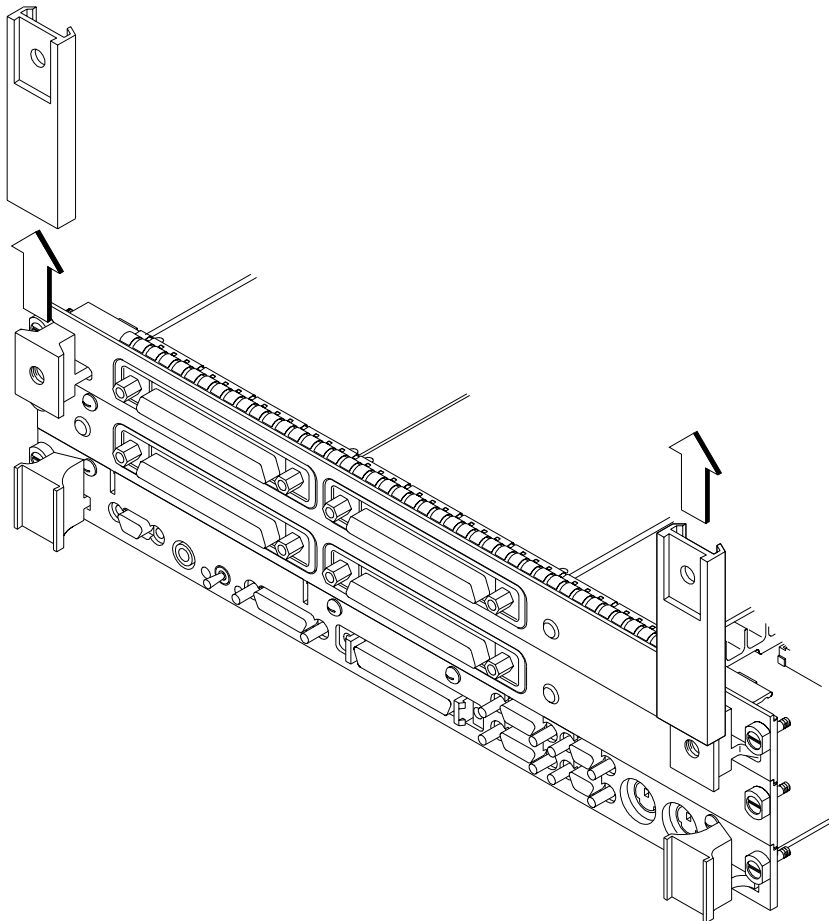

Figure 5-7 Removing the Sleeves

Field Replaceable Units
Removing and Replacing the PMC Adapters

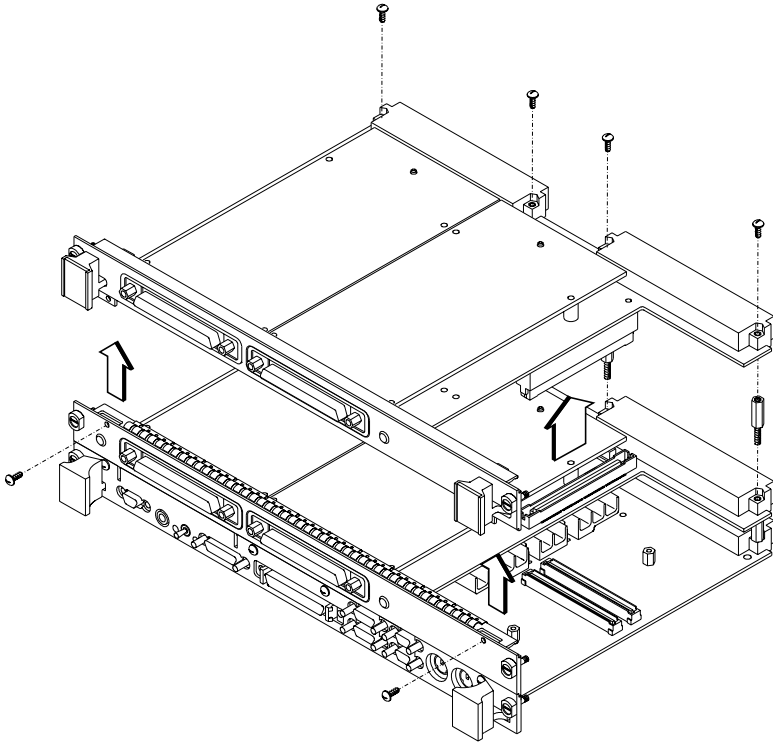

Figure 5-8 Removing the PMC Expansion Adapter

Field Replaceable Units Removing and Replacing the PMC Adapters

- 6 To remove a PMC card from the expansion adapter, remove the four screws from the bottom of the expansion adapter and separate the PMC card from the expansion adapter, as shown in Figure 5-9.

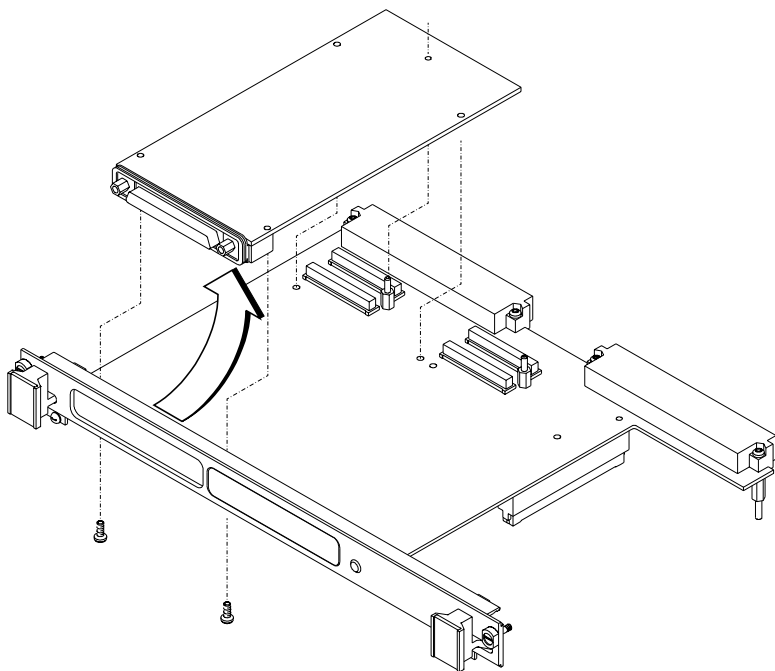

Figure 5-9 Removing a PMC card from the Expansion Adapter

Removing and Replacing the PMC Adapters

- 7 Remove the bridge adapter's four front panel screws, as shown in Figure 5-10.
- 8 Remove the bridge adapter's four VME connector screws, as shown in Figure 5-10.
- 9 Separate the bridge adapter from the board computer.

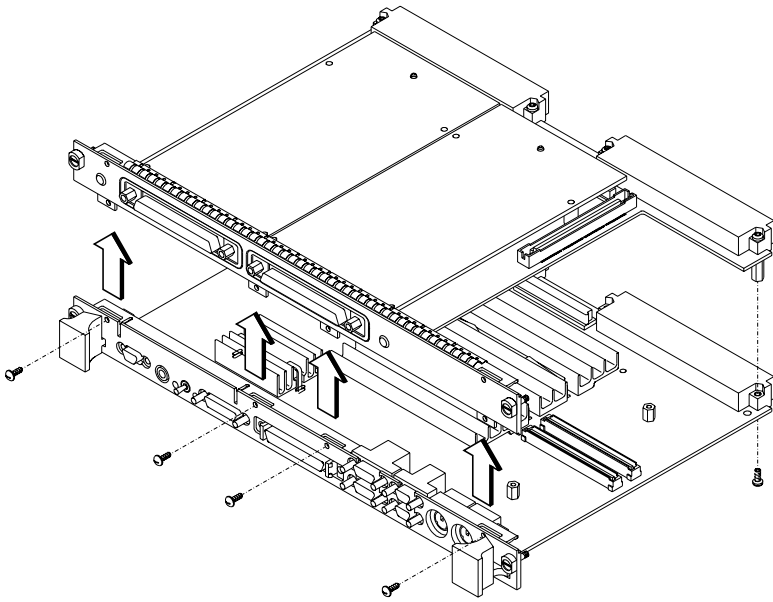

Figure 5-10 Removing the PMC Bridge Adapter

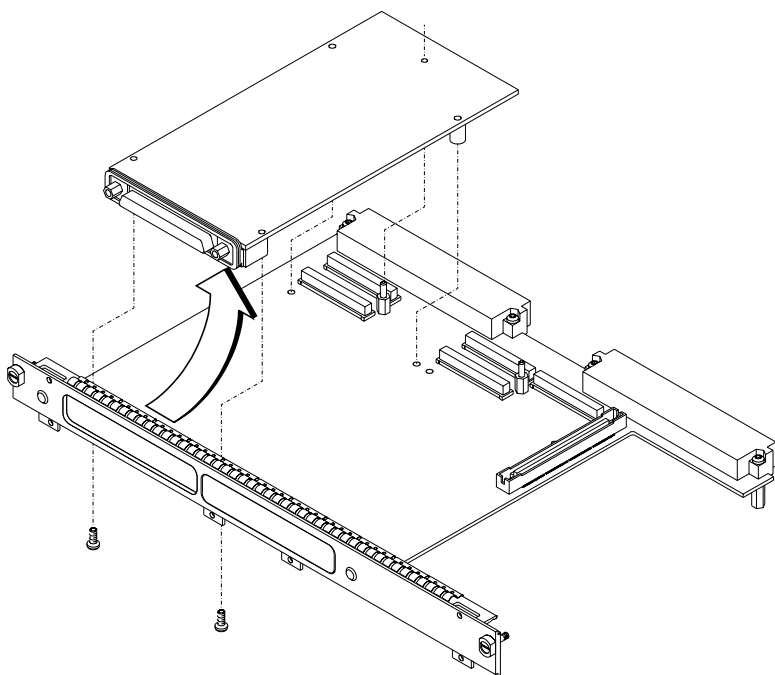

Figure 5-11 Removing a PMC card from the Bridge Adapter

- 10 To remove a PMC card from the bridge adapter, remove the four screws from the bottom of the bridge adapter and separate the PMC card from the bridge adapter, as shown in Figure 5-11.

NOTE:

To replace the adapters, reverse the steps in the procedure for removing the adapters.

When installing an expansion adapter, be certain that the connector between the bridge adapter and the expansion adapter is fully seated. This may require removing memory cards to access the bridge adapter.

Removing and Replacing an HCRX Graphics Board

An HCRX8 or HCRX24 Graphics board occupies the same position as the Expansion Kit adapter. These boards fasten to the 743 in almost the same way as the adapter, with four DIN screws and two M2.5X6 screws, however, there are an additional two small screws located on each side of the graphic's connector that fasten through the front panel.

Preliminary Requirements

Perform the following steps before removing an HCRX board from your Model 743:

- 1 Remove the 743 from its chassis. (Removing and Replacing the 743 Board Computer, page 5-9 .)

NOTE: There is one GSC connector on the left side of an HCRX board. To remove a GSC card from this connector see: Removing and Replacing GSC Graphics/FWD SCSI Cards

Removal

Follow these steps to remove the HCRX board from your Model 743:

- 1 Remove the two M2.5X6 screws from the bottom of the system board as shown in Figure 5-12.

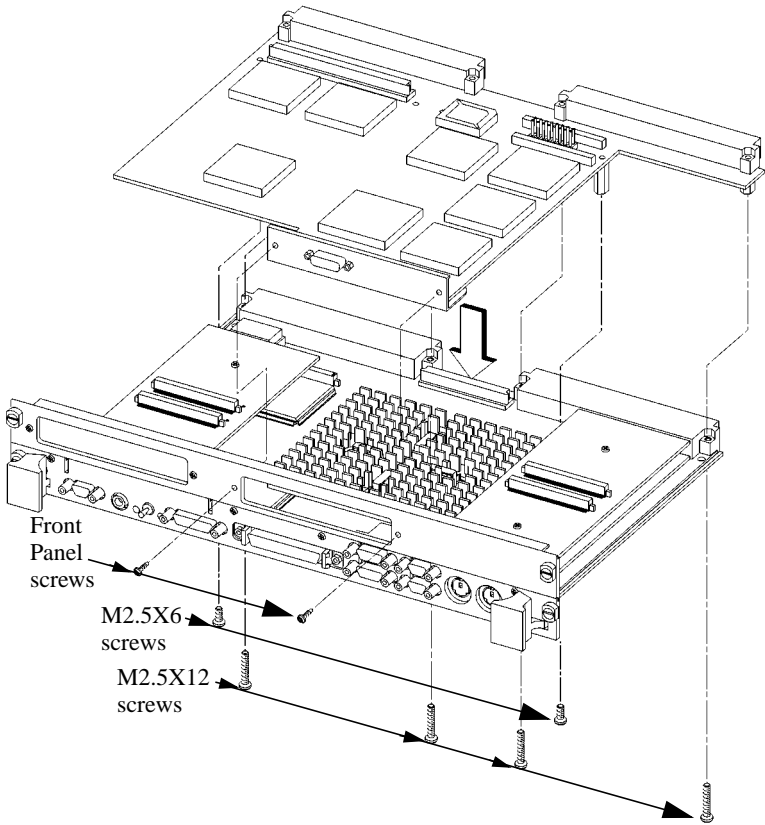

Figure 5-12 HCRX Board Fasteners

- 2 Remove the four DIN connector M2.5X12 screws from the bottom of the system board.
- 3 Remove the two small screws at each end of the graphic connector on the front panel.
- 4 Remove the HCRX board from the computer by lifting it straight up from the centered connector.

Replacement

To replace an HCRX board, reverse the steps in the procedure for removing a board.

Removing and Replacing the Front Panel Extension

This section provides step-by-step instructions for removing the front panel extension from your Model 743.

Preliminary Requirements

Perform these steps before removing the front panel extension from the Model 743:

- 1 Remove the 743. (Removing and Replacing the 743 Board Computer, page 5-9 .)
- 2 Remove any GSC cards. (Removing and Replacing GSC Graphics cards.)
- 3 Remove the Expansion adapter or HCRX board.

Removal and Replacement

Follow these steps to remove the front panel extension:

- 1 Remove the M2.5X6 screws which hold the panel extension to the front panel as shown in Figure 5-13.

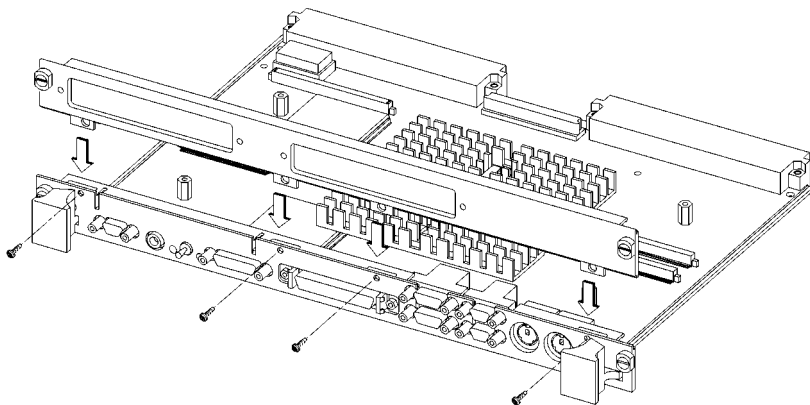

Figure 5-13 **Front Panel Extension Fasteners**

- 2 Pull the front panel extension up and off the front panel.

Field Replaceable Units
Removing and Replacing the Front Panel Extension

NOTICE:

To replace the front panel extension, reverse the steps for removing the front panel extension.

Removing and Replacing the Front Panel

This section provides step-by-step instructions for removing the front panel of your Model 743.

Preliminary Requirements

Perform the following steps before removing the front panel:

- 1 Remove the 743 from its chassis.
- 2 Remove any GSC card connector screws. (Removing and Replacing GSC Graphics cards.)
- 3 Remove the HCRX board (if installed) connector screws. (Removing HCRX board.)
- 4 Remove the front panel extension. (Removing Front Panel Extension.)

NOTE: The RFI clips on the front panel are not individually replaceable. Replacing the RFI clips requires the complete front panel.

Removal and Replacement

Follow these steps to remove the front panel:

- 1 Remove the interface port jack screws (There are two around each port, SCSI, video, etc.) using the appropriate 3mm (0.125-in.) or 4mm (0.160-in.) nutdriver. The Port Jack Screws are shown in Figure 5-14.

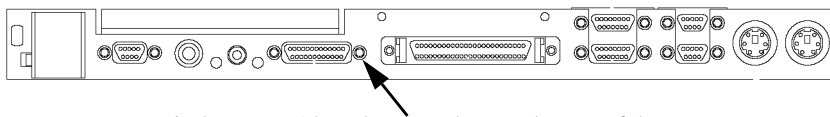

Port jack screws, 14 total, two each around seven of the ports.

Figure 5-14 Port Jack Screws

- 2 Remove the two small screws, one on each underside front corner of the board that fasten the front panel to the board.
- 3 Pull the front panel forward, away from and off the system board.
- 4 Remove the RFI clip on the two RS-232 ports.

Socketed ICs

This section provides step-by-step instructions for replacing the socketed integrated circuits.

You can replace the following socketed ICs in your Model 743, as shown in the accompanying figure:

Boot ROM; U54
EEPROM; U55
OEM ROM; U52

NOTE: The OEM ROM is customized for specific applications and is only available from the company who makes it. Consult the customer to find out what company their Model 743 VMEbus Board Computer was purchased from.

Preliminary Requirements

Perform the following steps before removing a socketed IC:

- 1 Remove the 743 from its chassis.
- 2 Remove accessory cards or boards which block the computer's left side and center positions.

Removing and Replacing Socketed ICs

Perform the following steps to remove a socketed IC. If you are replacing a socketed IC, reverse the following steps.

NOTE: Figure 5-15 depicts a stripped down board from the front, displaying and naming just the IC's.

- 1 Before removing the IC, note its position/orientation. The replacement IC must be installed in the same position. See Figure 5-15.

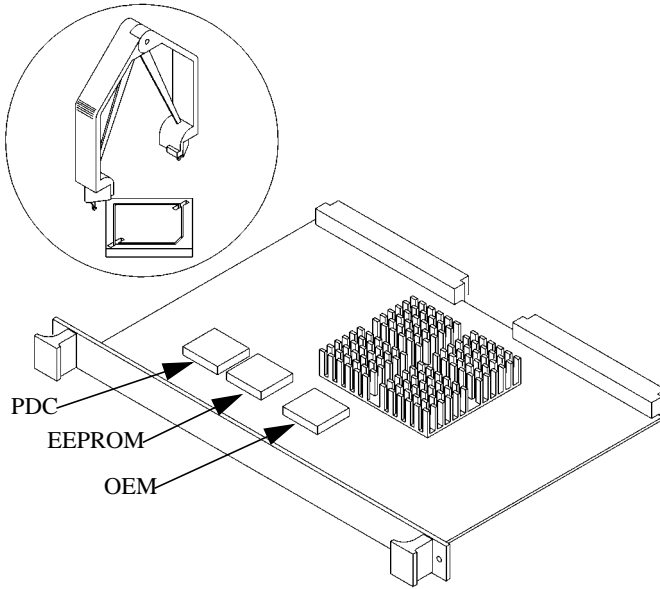

Figure 5-15 **Removable ICs**

- 2 Use the IC removal tool to carefully grasp and remove the IC.

Removing and Replacing the Real-Time Clock Battery

This section provides step-by-step instructions for removing and replacing the real-time clock in your Model 743.

Preliminary Requirements

WARNING:

Lithium batteries may explode if mistreated. Replace battery with only a Matsushita Electric BR-1616 three-volt lithium battery (HP part number 1420-0525). Use of any other battery may cause fire or explosion. Use the following guidelines when handling old batteries:

- Do not put lithium batteries in fires.**
- Do not try to recharge lithium batteries.**
- Do not disassemble lithium batteries.**

Removal

Perform the following steps before removing the RTC battery from your Model 743:

- 1 Remove the 743 from its chassis.
- 2 Remove any RAM or accessory cards installed at the board computer's left position.

Replacement

Follow these steps to replace the RTC battery:

- 1 Locate the battery behind the left RAM connector. It is held in place by a spring arm marked with a "+".
- 2 Push the edge of the battery, slipping it out of place, and remove the battery.
- 3 Install the new battery with its '+' side up by slipping it under the spring arm - AVOID LIFTING THE SPRING ARM.

Removing and Replacing the PCMCIA Adapter

Perform the following steps before removing the PCMCIA adapter from your Model 743rt:

- 1 Remove the 743rt from it's chassis. (Removing and Replacing the 743 Board Computer, page 5-9)
- 2 If an HCRX board or an Expansion kit adapter with a GSC card installed in the left slot is installed on the computer, remove them to the point where you can access the PCMCIA adapter. (See appropriate section in this chapter.)

Removal

- 1 Hold the computer up and look in the space between the board computer and the adaptor. Look for the positions of the standoffs holding the adapter away from the board computer; at these positions are the retaining screws holding the adaptor to the board computer.
- 2 Locate the retaining screw positions on the bottom of the board computer.
- 3 Remove the screws.
- 4 Grasp the adaptor card by the rear edge (edge closest to the DIN connectors and farthest away from the front panel) and remove the card from its connector and the board by lifting straight up.

Replacement

To replace a PCMCIA adapter, reverse the steps in the procedure for removal.



Reference Documentation

Introduction

This chapter provides information on related documentation for the Model 743. The references include the manual name and part number.

Table 6-1 **Reference Documentation**

Manual Title	Part Number
Model 743 Owner's Guide	A2636-90606
HP-UX 9.05 VME Configuration and Driver Development Guide	A2636-90020
VME Services for HP-UX 10	A4412-90022
Using the Audio Developer's Kit	B2355-90069
Support Media User's Manual	92453-90079
Support Tool Manager User Guide	5963-4444
ODE User Guide	5962-3648
HP 9000 Series 700 Diagnostics Manual, Volume 1	09740-90041
HP 9000 Series 700 Diagnostics Manual, Volume 2	09740-90043
HP 9000 Series 700 Support Tape/CD-ROM User's Manual	B2380-90000
PA-RISC Support Tools Manual Licensed Users Volume 1, SPU	5960-3149
PA-RISC Support Tools Manual Licensed Users Volume 2, Device Adapters/MUXes	5960-3153
PA-RISC Support Tools Manual Licensed Users Volume 3, LAN	5960-3153
PA-RISC Support Tools Manual Licensed Users Volume 4, SCSI	5960-3155
PA-RISC Support Tools Manual Licensed Users Volume 5, Disks	5960-3157
PA-RISC Support Tools Manual Licensed Users Volume 6, Tapes/Printers	5960-3159

Table 6-1 **Reference Documentation**

Manual Title	Part Number
PA-RISC Support Tools Manual Licensed Users Volume 7, Utilities	5960-3161
PA-RISC Support Tools Manual Licensed Users Volume 8, ISL Support Tools	5960-3163
PA-RISC Support Tools Manual HP Employees	5960-3165

Index

A

- accessories, 1-11
- accessory cards, 1-11
- air flow, 1-7
- altitude, 1-7
- audio, 2-11
 - connector, 2-12
 - pinouts, 2-12
- AUI LAN, 2-16
 - connector, 2-16
 - pinouts, 2-16

B

- battery, 2-25
- battery removal, 5-33
- BCH, 3-3
 - boot device, 3-7
 - main menu, 3-5
 - mode configuration, 3-12
 - path, 3-9
- boot console handler (BCH), 3-3
- boot device, 3-7
- boot options, 4-10
- boot ROM, 2-4
- boot search control, 3-14
- BPN, 3-27
- BPR, 3-27

C

- cables, 1-12
- cards
 - graphics, 2-23
 - memory, 2-24
 - RAM, 2-24
- clock, 1-2, 2-25
- clocks, 1-2
- codes
 - chassis, 4-25, 4-27
 - error, 4-8
- compatibility, 1-3
- component information, 3-25
- configuration
 - graphics, 3-29
- configurations
 - supported, 1-5

conncector

- video, 2-6
- connector
 - audio, 2-12
 - AUI LAN, 2-16
 - parallel, 2-13
 - PS/2, 2-19
 - SCSI, 2-17
 - serial, 2-15
- console path, 3-10
- console search control, 3-15
- control flags, 3-16
- conversion cables, 1-12
- CPU circuit, 2-4

D

- diagnostics
 - running ODE-based, 4-14
 - documentation, reference, 6-2
- dual slot upgrades, 1-4

E

- ECC, 2-7
- EEPROM, 2-4, 3-3
- electromagnetic certifications,
 - 1-7
- electrostatic discharge, v
- emergency mode, 3-13
- emissions
 - regulations, iii
- environmental
 - air flow, 1-7
 - altitude, 1-7
 - humidity, 1-7
 - requirements, 1-7
 - temperature, 1-7
- ESD, v
- expansion
 - GSC, 1-11
 - PMC, 1-11
- extended selftest, 4-6
- external devices, 1-12

F

- FCC, iii

- Federal Communications Commission (FCC), iii
- firmware
 - information, 3-21
 - function, 2-7

G

- graphics, 2-6
- graphics capability, 1-3
- graphics cards, 2-23
- graphics configuration, 3-29
- graphics options, 1-3
- GSC cards, 1-11
 - removal, 5-15
- GSC expansion, 1-11
- GSC mezzanine cards, 1-11

H

- hardware information, 3-23
- hardware support, 1-9
- HCRX graphics cards, 1-11
- HPMC errors, 4-18
- humidity, 1-7

I

- I/O
 - map, 2-10
- I/O controller, 2-10
- information
 - component, 3-25
 - hardware, 3-23
- interactive testing, 3-18, 4-13
- interfaces, 2-11
 - audio, 2-11
 - parallel, 2-13
 - PS/2, 2-19
 - SCSI, 2-17
 - serial, 2-14
- interval timers, 2-26
- ISL, 3-3
 - environment, 4-3
 - invoking ODE-based diagnostics, 4-14
 - program, defined, 4-3

Index

- K**
keyboard, 1-13, 2-7
keyboard path, 3-11
keyboard search control, 3-15
Korean regulations, iv
- L**
LAN, 1-12, 2-16
LAN ID, 2-4
LAN, see also AUI LAN, 2-16
LED
 indicators, 2-5
 power, 2-5
 system failure, 2-5
LEDs, 2-4
 error codes, 4-9
- M**
main memory, 1-4
main menu, 3-5
man commands
 cstm, 4-16
 mstm, 4-16
 xstm, 4-16
map
 I/O, 2-10
 memory, 2-8
memory
 address ranges, 4-24
 cards, 2-24
 circuit, 2-7
 configurations, 1-4
 map, 2-8
 slots, 2-24
memory cards, 1-11
mezzanine cards, 1-11
mode configuration, 3-12
model type, 1-2
monitors, 1-3
mouse, 1-13
- O**
ODE-based diagnostics, 4-14
offline diagnostics environment (ODE), 4-14
operating ranges, 1-7
operating systems, 1-2
options
 graphics, 1-3
- P**
parallel, 2-13
 connector, 2-13
 pinouts, 2-14
part numbers, 5-5
parts
 replaceable, 5-4
path configuration, 3-9
PCMCIA, 1-11
PDC, 3-21
pinouts
 audio, 2-12
 AUI LAN, 2-16
 parallel, 2-14
 PS/2, 2-19
 SCSI, 2-18
 serial, 2-15
 video, 2-6
 VME, 2-20
PMC
 bridge, 1-11
 expansion, 1-11
PMC adapters, 5-19
power
 distribution, 2-27
 requirements, 1-6, 2-27
power requirements, 1-6
precautions
 electrostatic discharge, v
 primary path, 3-10
 product description, 1-2
PS/2, 2-19
 connector, 2-19
 pinouts, 2-19
- R**
RAM card, 4-15
RAM cards, 1-11, 2-24
 removal, 5-13
RAM stacks, 2-24, 4-15
real-time clock, 2-25
reference documentation, 6-2
regulations
 emissions, iii
 regulatory
 compliance, 1-7
 electromagnetic, 1-7
 FCC, iii
 safety, 1-7
 statements, iii
 VCCI, iv
removal
 battery, 5-33
 board computer, 5-9
 front panel, 5-28
 GSC cards, 5-15
 GSC expansion adapter, 5-17
 HCRX card, 5-26
 PCMCIA, 5-34
 PMC adapters, 5-19
 RAM cards, 5-13
repair philosophy, 1-9
repair services, 1-14
replaceable parts, 5-4
RS-232 ports, 2-14
- S**
safety, 1-7
 statements, iii
safety precautions, 5-8
schematics, 1-9
SCSI
 connector, 2-17
 pinouts, 2-18
SCSI interfaces, 2-17
selftests, 4-4
selftests, extended, 4-6
serial
 connector, 2-15
 pinouts, 2-15
serial ports, 2-14
slot configuration, 1-2
socketed ICs, 5-31
speaker, 1-12
standard cables, 1-12
standard features, 1-4
support, 1-9
supported configurations, 1-5

Index

supported products, 1-10
system configuration, 3-27
system verification tests
 running, 4-16

T

technical information, 1-6
temperature, 1-7
 board, 1-8
testing
 interactive, 4-13
tests
 interactive, 3-19
 running system verification,
 4-16
timer
 watchdog, 2-26
timers
 interval, 2-26
tools, 5-7

U

upgrades, 1-4
 3-slot, 1-5
 dual slot, 1-4
user interface, 1-3

V

video
 connector, 2-6
 pinouts, 2-6
VME
 slot configuration, 1-2
VME controller, 2-20
VME pinouts, 2-20

W

watchdog timer, 2-26